



Review Paper

A critical review of multiple alternative pathways for the production of a high-value bioproduct from sugarcane mill byproducts: the case of adipic acid

Yakim Cronjé, Somayeh Farzad*, Mohsen Mandegari, Johann F. Görgens

Department of Process Engineering, Stellenbosch University, Private Bag X1, Matieland 7602, South Africa.

HIGHLIGHTS

- Biobased adipic acid (ADA) production has great potential to revitalize the sugarcane industry.
- Compared to fossil-based, biobased ADA production can lower GHG emissions up to 80%.
- Biobased ADA production from A-molasses is only 15% more expensive compared to fossil-based ADA.
- The intermediate *cis,cis*-muconic acid found the best route for ADA production.
- The adoption of biobased ADA faces competition from the petrochemical market.

GRAPHICAL ABSTRACT

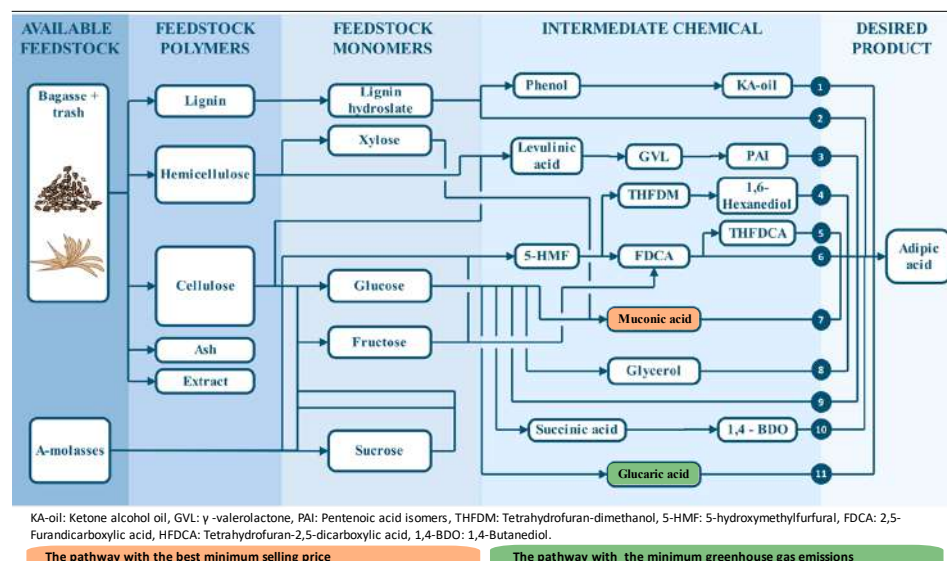

ARTICLE INFO

Article history:

Received 20 July 2023
 Received in revised form 15 August 2023
 Accepted 24 August 2023
 Published 1 September 2023

Keywords:

Biorefinery
 Adipic acid
 Process development
 Sugarcane
 Techno-economic analysis
 Greenhouse gas emissions

ABSTRACT

Biobased fuels, chemicals, and materials can replace fossil fuel products and mitigate climate change. Sugarcane mills have the potential to produce a wider range of biobased chemicals in a similar approach to bioethanol production, including adipic acid. Multiple alternative pathways for converting simple sugars into adipic acid have been described, with the potential for integration into a sugar mill. The economics and expected greenhouse gas emissions reductions compared to fossil-based adipic acid were investigated in the present study to identify preferred pathways for implementation in sugarcane biorefineries. Nine biobased pathways for adipic acid production were screened for technical performances, resulting in the selection of four preferred options for rigorous comparison, i.e., direct microbial conversion of sugars, and production *via cis,cis*-muconic acid, glucaric acid, and glycerol as intermediate, obtained from sugars. The minimum selling prices of adipic acid for an attractive return on investment were determined for these pathways, using either A-molasses or a combination of A-molasses and pretreated sugarcane lignocelluloses in biorefineries designed to be energy-self-sufficient. Adipic acid production from A-molasses *via cis,cis*-muconic acid was the best overall performing scenario with the lowest minimum selling price of USD 2,538/Mt and lowered greenhouse gas emissions (2,325 g CO₂ eq/kg wet) compared to fossil-based adipic acid production. The scenarios with combined A-molasses and lignocellulosic feedstock had increased minimum selling prices by 29 to 101% compared to adipic acid production from A-molasses *via cis,cis*-muconic acid.

© 2023 BRTeam. All rights reserved.

* Corresponding author at:
 E-mail address: sfarzad@sun.ac.za

Please cite this article as: Cronjé Y., Farzad S., Mandegari M., Görgens J.F. A critical review of multiple alternative pathways for the production of a high-value bioproduct from sugarcane mill byproducts: the case of adipic acid. Biofuel Research Journal 39 (2023) 1933-1947. DOI: [10.18331/BRJ2023.10.3.5](https://doi.org/10.18331/BRJ2023.10.3.5)

Contents

1. Introduction.....	1934
2. Biobased production pathways for adipic acid.....	1935
2.1. Direct conversion of sugars to adipic acid.....	1935
2.2. Glycerol as intermediate for sugars conversion to adipic acid.....	1935
2.3. γ -valerolactone as intermediate for sugars conversion to adipic acid.....	1936
2.4. 5-HMF as intermediate for sugars conversion to adipic acid.....	1936
2.5. 1,4-butanediol as intermediate for sugars conversion to adipic acid.....	1937
2.6. Glucaric acid as an intermediate for sugar conversion to adipic acid.....	1937
2.7. Muconic acid as an intermediate for sugars conversion to adipic acid.....	1938
2.8. Comparison of sugars-to-adipic acid pathways.....	1938
3. Detailed techno-economic and GHG emission comparison.....	1938
3.1. Simulations development.....	1938
3.1.1. Adipic acid production <i>via</i> direct microbial conversion of sugars.....	1939
3.1.2. Adipic acid production <i>via</i> glycerol as intermediate.....	1940
3.1.3. Adipic acid production <i>via</i> intermediate cis,cis-muconic acid.....	1940
3.1.4. Adipic acid production <i>via</i> intermediate glucaric acid.....	1940
3.2. Economic assumptions.....	1941
3.3. Greenhouse gas emissions.....	1941
3.4. Performance comparison.....	1941
3.4.1. Mass and energy balances.....	1942
3.4.2. Economics.....	1942
3.4.3. Environmental impacts.....	1943
4. Policy and practical implications of the present study.....	1944
5. Conclusions and future perspectives.....	1944
Acknowledgements.....	1944
References.....	1944

Abbreviations

1,4-BDO	1,4-Butanediol	NOP	Nitric oxidation process
1,5-HMF	5-Hydroxymethylfurfural	OPEX	Operating expenditure
1G	First-generation	PAI	Pentenoic acid isomers
2G	Second-generation	PRET	Pretreatment
ADA	Adipic acid	STORE	Storage
ADAPROD	Adipic acid production	TCI	Total capital investment
ADAPUR	Adipic acid purification	TEA	Techno-economic analysis
CAPEX	Capital expenditure	THFDCA	Tetrahydrofuran-2,5-dicarboxylic acid
CCMA	cis,cis-Muconic acid	THFDM	Tetrahydrofuran-dimethanol
CHP	Combined heat and power	UTIL	Utilities
ENZCOND	Enzymatic hydrolysis and feed conditioning	WWT	Wastewater treatment
FDCA	2,5-Furandicarboxylic acid	Units	
GA	Glucaric acid	Concentration	Grams per litre (g/L)
GHG	Greenhouse gases	Yield	Gram per gram or moles per mole (g/g or mol/mol)
GVL	γ -valerolactone	Productivity	Grams per liter per hour (g/L.h)
INTPROD	Intermediate purification	Temperature	Degrees Celsius ($^{\circ}$ C)
INTPUR	Intermediate production	Pressure	bar (100 000 N/m ²)
KA	Ketone-alcohol	Mass flow	Metric tonnes per hour (Mt/h)
LA	Levulinic acid	Cost	Million US dollars (MUSD)
MEV	Multi-effect vacuum evaporation	GHG emissions	Gram CO ₂ equivalent per kg wet product (g CO ₂ eq/kg wet)
MSP	Minimum selling price		

1. Introduction

The production of fuels, chemicals, materials, and energy from fossil fuels has led to significant deterioration of our environment due to its contribution to climate change. The production of economically important chemicals from biobased resources in a circular economy is one strategy for industrial development that can mitigate the negative effects of a linear economy based on fossil fuels (Ewing et al., 2022).

The global sugarcane industry holds substantial potential for the co-production of preferred chemicals to replace fossil-derived products (Jarunglumlert et al., 2022), similar to the extensive bioethanol production taking place at sugar mills around the world, especially in Brazil (Farzad et al.,

2017). Although chemical products such as furfural or amino acids are produced at some sugar mills, there remains a plethora of platform chemicals, materials, and advanced biofuels yet to be produced by sugarcane mills (Ratshoshi et al., 2021). Molasses is a low-value byproduct of the sugar industry that could be utilized to produce valuable bioproducts, with the option to supplement this first-generation (1G) feedstock with sugarcane lignocelluloses such as bagasse as second-generation (2G) feedstocks (Moonsamy et al., 2022). The use of 2G feedstocks in such biorefineries is of interest due to the limited supply of 1G-feedstocks (Han, 2016), the potential competition of the latter with food products (Gunukula and Anex, 2017), and the need to maximize value-addition to available lignocelluloses, compared to conventional applications like electricity

production (Fallahi et al., 2021). Available lignocelluloses are therefore applied both as process energy (Coşgun et al., 2023) to ensure that sugar mills and annexed biorefineries remain energy self-sufficient, as well as for conversion into valuable chemical products, where the latter will introduce additional process energy demands; for example, the energy-intensive lignocelluloses pretreatment process (Yan Cheah et al., 2020). In the so-called 1G2G strategy, the sugars obtained from molasses (1G) are combined with sugars obtained from lignocelluloses through pretreatment-hydrolysis, allowing co-processing of these to the chemical product of interest at a larger production scale, while a portion of the 2G feedstock (hereinafter referred to as the "bypass") is used to produce the utilities required by the biorefinery and sugar mill (Soltanian et al., 2019).

Adipic acid (ADA) is one of many potential chemical or material products that can be produced in a sugarcane biorefinery. Biobased ADA is primarily used in the manufacturing of nylon 6,6-fiber and -resin (Grand View Research, 2021) to replace the fossil-derived ADA presently used in its manufacture, and therefore named one of the most important dicarboxylic acids by the United States Department of Energy, having a very large potential market value (Zhao et al., 2018). Presently biobased ADA has a small market presence: the global production of fossil-based ADA in 2020 was 3 million tonnes, valued at USD 6.7 billion (Grand View Research, 2021), while the biobased ADA production capacity was only 2700 tonnes in 2017 (Skoczinski et al., 2020). Since there was no market price for biobased ADA, the techno-economic analyses (TEAs) in the present study compared its production costs to fossil-based ADA.

A biobased pathway for ADA production should address not only the carbon source in its chemical structure but also the environmental concern of fossil-based ADA production, i.e., nitrous oxide production. The majority (~93%) of fossil-based ADA is produced via the nitric oxidation process (NOP), which converts fossil-derived benzene to an intermediate mixture of cyclohexanol and cyclohexanone, referred to as ketone-alcohol (KA) oil; KA oil is further upgraded to ADA by oxidation with an excess amount of nitric acid (Rios et al., 2021). The final step in the process is associated with the stoichiometric production of nitrous oxide, a greenhouse gas (GHG) 300 times more potent than carbon dioxide (Skoog et al., 2018).

Limited TEAs and GHG analyses are available on the various biobased ADA pathways and primarily focus on the development of a single pathway rather than a rigorous and consistent comparison of alternative biobased pathways for its production from sugars (Choe et al., 2021; Oh et al., 2022). Only one report has compared alternative pathways for biobased ADA production utilizing either pure glucose or glucose derived from corn as a feedstock (Gunukula and Anex, 2017). In the context of a sugarcane biorefinery, ADA could be obtained from a mixture of three or four primary sugars, including glucose, fructose, sucrose, and xylose (Morakile et al., 2022). Table 1 compares the present review paper with some previously published articles (2017-2023) on biobased ADA production. As can be seen, this review paper comprehensively covers different pathways, feedstock, and indicators for biobased ADA production.

This study compared nine alternative pathways for ADA production from sugarcane materials and, based on technical performances reported previously, selected four pathways offering the most superior performance. The latter technical screening identified the best production parameters (yield and volumetric productivity) for each pathway and also considered their advantages and disadvantages for implementation in an energy-self-sufficient biorefinery with limited feedstock. Process simulations and techno-economic models were constructed for the 1G and 1G2G scenarios of the selected four pathways to

determine the most attractive economically, based on ADA's minimum selling price (MSP), to provide an acceptable return on investment. Cradle-to-gate GHG analyses were also conducted for the resulting eight ADA production scenarios to compare economic attractiveness and determine which pathway should be prioritized for implementation.

2. Biobased production pathways for adipic acid

Multiple alternative pathways for the conversion of the chemical components found in sugarcane into ADA have been reported, utilizing simple sugars, lignin monomers, or complex biopolymers (e.g., from lignocelluloses) into intermediates that can be further converted into ADA (Fig. S1, Supplementary file). The present review was limited to nine reported pathways that could utilize the four main sugars (glucose, fructose, sucrose, and xylose) as found in molasses and the carbohydrate contents of lignocelluloses. The pathways either converted these sugars into intermediates such as γ -valerolactone (Fig. S1, 3), 5-hydroxymethyl furfural (Fig. S1, 4 – 6), *cis,cis*-muconic acid (Fig. S1, 7), glycerol (Fig. S1, 9), 1,4-butanediol (Fig. S1, 10) or glucaric acid (Fig. S1, 11) or achieved in direct microbial conversion of sugars into ADA (Fig. S1, 8).

2.1. Direct conversion of sugars to adipic acid

The direct conversion of sugars into the desired product is often a preferred pathway, as it presents a less complex process with potentially lower energy demands and processing costs; however, these intended benefits would be dependent on the technical performances of the direct conversion method. Direct microbial conversion of glucose into ADA has been reported for biocatalysts such as *Thermobifida fusca* (Deng and Mao, 2015) and engineered *Escherichia coli* (Zhao et al., 2018; Zhou et al., 2020), with the best performances thus far obtained with engineered *E. coli* in the reverse adipate degradation pathway (Skoog et al., 2018). The challenge has been to produce ADA at yields and titers exceeding 0.045 g/g glucose and 2 g/L, respectively (Yu et al., 2014; Babu et al., 2015). Recent reports have demonstrated an ADA yield of 0.50 g/g glucose that was equivalent to 93.1% of the theoretical maximum yield, which could be produced at a final titer of 14.9 g/L after 78 h of bioconversion (Zhao et al., 2018; Zhou et al., 2020). Furthermore, improvements in the cost of production can be obtained by improving yields beyond 0.5 g/g and achieving titers between 50 to 100 g/L (Skoog et al., 2018).

2.2. Glycerol as intermediate for sugars conversion to adipic acid

Alternative to directly converting glucose to ADA, glycerol can be produced as an intermediate product; conversion of glycerol to ADA allows for a higher final titre than for direct microbial conversion of glucose to ADA; the ADA can be produced from glycerol at a yield of 0.425 g/g glycerol and a titre of 68 g/L after 88 h of fermentation (Zhao et al., 2018; Zhou et al., 2020). The titer is a significant improvement from a glucose feed, and significant benefits would be seen in downstream purification utility requirements (Pothakos et al., 2018). The glycerol production from a sugar feedstock is a well-studied field where yields and titers as high as 0.55 g/g glucose and 219 g/L have been reached, respectively (Overkamp et al., 2002).

Table 1. Comparing the present review paper with previously published papers (2017-2023) on biobased adipic acid production.

Reference	Various Production Pathways	Process Development	Feedstock				Indicator	
			Lignocellulose	Glucose	Sucrose	Xylose	Economic	Environmental
Gunukula and Anex (2017)	✓	✓	-	✓	-	-	✓	-
Rios et al. (2021)	✓	-	✓	✓	-	✓	✓	-
Choe et al. (2021)	-	✓	✓	✓	-	✓	✓	✓
Oh et al. (2022)	-	✓	✓	✓	-	✓	✓	✓
This review	✓	✓	✓	✓	✓	✓	✓	✓

2.3. γ -valerolactone as intermediate for sugars conversion to adipic acid

The biobased production pathway for ADA from γ -valerolactone (GVL) incorporates four conversion steps. This starts with the production of levulinic acid (LA), for which lignocelluloses are often preferred as feedstock. LA is catalytically converted to GVL and then pentenoic acid isomers (PAI) before final conversion to ADA, as demonstrated in Figure 1 (Han, 2016). An in-depth review of the production of GVL from lignocellulosic biomass has previously been explored, where more detailed information on GVL production can be found (Alonso et al., 2013a).

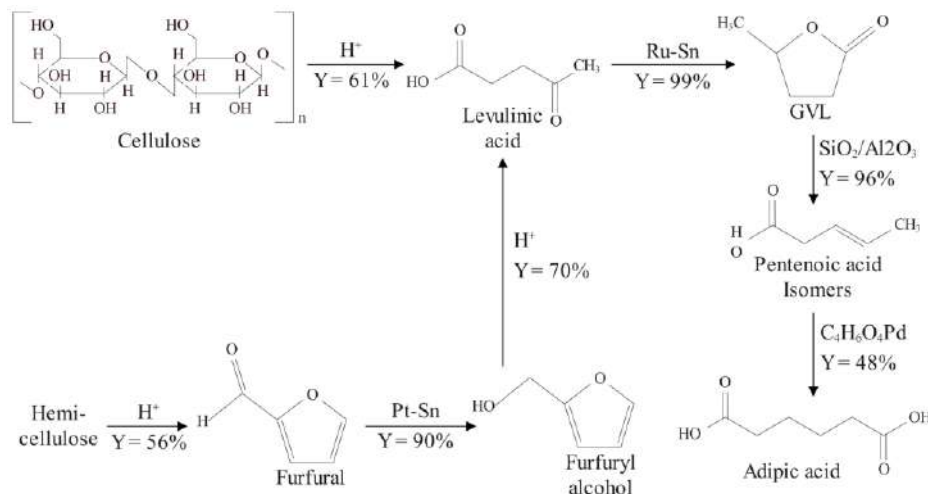

Fig. 1. Adipic acid production via intermediate γ -valerolactone (GVL). Adapted from Han (2016).

Only a few publications have been found on the production of ADA from GVL (Wong et al., 2015). The conversion of GVL to ADA can be achieved through the reactive distillation of GVL with a silica-alumina catalyst (Si/Al 135) at temperatures ranging between 188 and 199 °C to produce PAI, which is further converted to ADA (Nobbs et al., 2016). The PAI is produced in different isomers that cannot easily be separated from one another, and therefore all the isomers need to be converted to ADA (Nobbs et al., 2016). This has been achieved by a hydroxycarbonylation reaction using a palladium diphosphine catalyst as well as a methanesulfonic acid co-catalyst (Nobbs et al., 2016).

Based on current advancements in ADA production from GVL, the preferred process uses GVL as a solvent in both the production of LA and its conversion to GVL, which serves as an intermediate for biobased ADA production (illustrated in Fig. 1) (Alonso et al., 2013a). GVL solubilizes the biomass effectively, thereby avoiding humins formation known to clog the reactors when 2G feedstocks are used (Alonso et al., 2013b). In addition, it also decreases furfural degradation, implying more hemicellulose is converted to LA and ultimately ADA promoting higher product production (Alonso et al., 2013a).

Although the GVL-based process was developed to use lignocellulosic feedstock, success has also been reached in utilizing simple sugars fructose, glucose, and sucrose for LA production in a GVL solvent (Qi et al., 2014). The drawback of this process is the low calculated overall mass yield of 0.23 g/g simple sugars (Nobbs et al., 2016b), assuming that A-molasses (the syrup taken from the first stage of crystallization in a sugar factory) can be utilized like that of pure, simple sugars. Conversion of the sugars or biomass to the precursor LA also requires a homogeneous catalyst (Alonso et al., 2013b), which introduces complexity in recovery compared to using a heterogeneous catalyst. This pathway requires four high-temperature (> 130°C) conversion steps, which would translate into a high-energy demanding pathway that is likely to have a negative impact on both the economics and environmental burdens (Pothakos et al., 2018), especially in the context of an energy self-sufficient sugarcane biorefinery.

2.4. 5-HMF as intermediate for sugars conversion to adipic acid

Multiple pathways to produce ADA by producing 5-hydroxymethyl furfural (5HMF) as an intermediate from simple sugars, such as glucose and fructose, have been reported (Beerthuis et al., 2015). The production processes can either consist of two or three additional conversion steps from 5-HMF before ADA is produced through additional intermediates such as 2,5-furandicarboxylic acid (FDCA), tetrahydrofuran-2,5-dicarboxylic acid (THFDCA), tetrahydrofuran-dimethanol (THFDM) and 1,6-hexanediol-5-HMFol as shown in Figure 2.

The pathway through 5-HMF, FDCA, and THFDCA for ADA production may provide a high overall mass yield (calculated as 0.44 g/g A-molasses) and productivity (4.2 g/L.h) (Zhou and Zhang, 2016), assuming that all of the sugars in A-molasses will participate in these conversions like processes using pure, simple sugars, as reported (Boussie et al., 2016; Motagamwala et al., 2018). Production parameters such as yield, titer, and productivity provide good indications of whether a conceptual pathway would lead to more successful economics (Skoog et al., 2018); pathways with higher yields and volumetric productivity are more attractive. The alternative pathway that directly converts FDCA (produced from 5-HMF) into ADA provides a calculated yield of 0.19 g/g A-molasses and a productivity of 0.137 g/L.h, also if all the sugars in A-molasses would participate efficiently in 5-HMF production; this is significantly lower than the previous, longer pathway (Wei et al., 2019). The alternate pathway through 5-HMF, THFDM, and 1,6-hexanediol would achieve an overall yield and productivity of 0.44 g/g A-molasses and 0.37 g/L.h (Buntara et al., 2011); although the overall yield is attractive, the much lower productivity of this pathway would increase equipment sizes, which would be likely to increase the capital expenditure (CAPEX) of the process (Moungoungui-diallo et al., 2018).

The production of 5-HMF and FDCA using the same solvents and heterogeneous catalysts is preferred to simplify purification requirements. The production of 5-HMF and FDCA is well studied, with multiple reports on variations in catalysts, solvent, temperatures, and pressures, all resulting in similar yields (Dutta et al., 2019). The production of 5-HMF is an energy-intensive process, which may be problematic for an energy-self-sufficient biorefinery scenario. Energy self-sufficiency is achieved by utilizing the 2G feedstock for energy production, and in biorefineries annexed to a sugar mill, this supply is limited (Nieder-Heitmann, 2019b). A TEA study conducted on 5-HMF production from A-molasses found that only 22.7% of the available bagasse remained after production (Louw et al., 2023). This could be problematic for ADA production as the conversion of 5-HMF to FDCA is conducted at high temperatures ranging between 120 and 180 °C

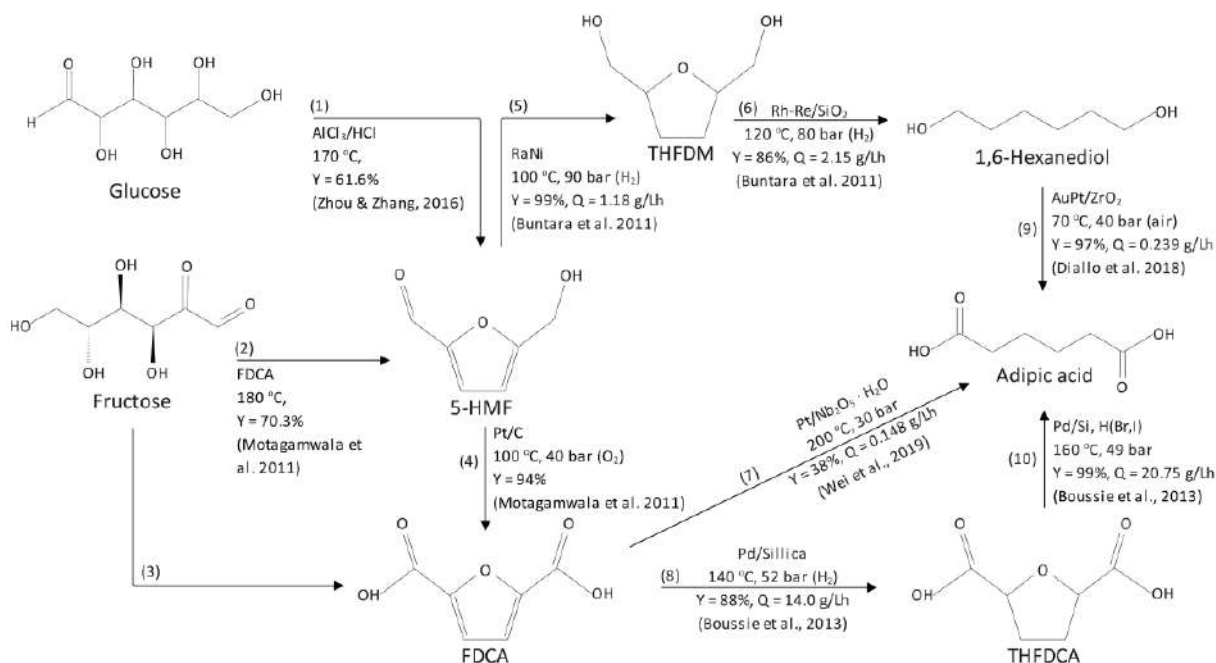

Fig. 2. Adipic acid production pathways via the intermediate 5-hydroxymethyl furfural (5-HMF). THFDM: Tetrahydrofuran-dimethanol, FDCA: 2,5-Furandicarboxylic acid, THFDCA: Tetrahydrofuran-2,5-dicarboxylic acid. Adopted from Beerthuis et al. (2015).

(Dutta et al., 2019), followed by high temperature (140 °C) hydrogenation to THFDCA (Boussie et al., 2016) and a final high temperature (160 °C) hydrodeoxygenation conversion to ADA (Boussie et al., 2016). In addition to these high-temperature conversions, intermediate energy-intensive purification and recycling steps are required for solvents after FDCA and ADA production (Boussie et al., 2016).

2.5. 1,4-butanediol as intermediate for sugars conversion to adipic acid

The direct microbial conversion of sugar to 1,4-butanediol (1,4-BDO) by an engineered strain of *E. coli*, before further upgrading to ADA, is the preferred method of producing ADA via the intermediate. The production of ADA via the 1,4-BDO can be accomplished by directly converting sugar to 1,4-BDO or following an indirect route by first converting sugars to succinic acid. The direct production of 1,4-BDO resulted in a better economic outcome than the indirect route, with an MSP of USD 1.8/kg compared to USD 3.6/kg, respectively (Satam and Realf, 2020). The indirect route suffers from thermal separation techniques that have a negative effect on capital investment, operating expenditure (OPEX), and GHG emissions (Satam and Realf, 2020). The direct conversion of a sugar feedstock to 1,4-BDO reached a yield of 0.4 g/g glucose produced at a titre of 78.4 g/L after 27 h of fermentation (Barton et al., 2015). In more recent literature, there have been advancements in utilizing glucose and xylose co-feed to produce 1,4-BDO at yields of 0.25 g/g and titers of 9.6 g/L (Guo et al., 2022).

The conversion of 1,4-BDO to ADA is the least explored pathway compared to all other pathways investigated, with a single patent reporting this conversion step (Paulik et al., 1988). The conversion of 1,4-BDO to ADA is achieved through a catalytic carboxylation reaction on a rhodium-based catalyst with a yield of 74% at a temperature of 175 °C and 48 bar in a carbon monoxide environment (Beerthuis et al., 2015). This conversion was accomplished by first converting the 1,4-BDO to 1,4-butanediol diacetate (BDDA); minimal information is available on this conversion step, although the rest of the reaction is well studied (Dake et al., 1987).

2.6. Glucaric acid as an intermediate for sugar conversion to adipic acid

One of the more studied pathways for ADA production is via the intermediate glucaric acid (GA), which can be produced biologically or

chemically from a sugar feedstock. Biological production of GA suffers from low yields; the highest achieved on a sugar substrate only reached 0.29 g/g glucose using an engineered strain of *E. coli* (Moon et al., 2010). In addition, GA is toxic to *E. coli* at concentrations above 5 g/L (Rios et al., 2021), and therefore the produced titer of GA remained low, ranging between 1.1 and 2.4 g/L (Moon et al., 2010; Reizman et al., 2015). Engineered strains of *Saccharomyces cerevisiae* are generally more tolerant to organic acids (Rios et al., 2021), although titers beyond 6 g/L have not been reported (Chen et al., 2018).

Chemical conversion of glucose to GA via catalytic oxidation on a platinum-carbon supported (Pt/C) catalyst performed significantly better, producing GA with yields as high as 73% at 80 °C and 13.8 bar (Lee et al., 2016). The catalytic oxidation of pure glucose produces an array of byproducts such as arabinonic acid, tartaric acid, oxalic acid, formic acid, etc. (Fig. S2, Supplementary file), which is critically dependent on the reaction pH and whether the pH is controlled, on the type of catalyst, temperature, and pressure (Dirkx and van der Baan, 1981; Derrien et al., 2017). Such a wide spectrum of products complicates downstream separation and would generally lead to higher CAPEX and OPEX (Gunukula and Anex, 2017). Chemical production of GA was demonstrated with pure glucose feedstock only, which would present challenges when utilizing an impure glucose feedstock such as molasses or a blend of sugars from molasses and lignocelluloses. Fortunately, A-molasses contains fewer non-sucrose impurities, making it more suitable for chemical conversion than C-molasses (B- and C-molasses, syrup taken from the second and third stages of crystallization of sugar production process, respectively) (Dogbe et al., 2020). It is unclear how the fructose fraction of an A-molasses feedstock would behave under the chemical oxidation conditions for GA production.

The GA is upgraded to ADA via a hydrodeoxygenation reaction using a heterogeneous metal catalyst and a halogen promoter in an organic acid solvent (Boussie et al., 2014). Numerous combinations of catalysts, halogen promoters, and solvents have been tested (Boussie et al., 2016), but the best results have been achieved on a platinum-rhodium (Pt-Rh) bimetallic catalyst with hydrogen bromide as the halogen promoter in an acetic acid solvent (Boussie et al., 2016). ADA was produced at a molar yield of 89% with byproducts 2- and 3- hydroxyadipic acid at a temperature of 160 °C and 50 bar hydrogen (H_2) (Boussie et al., 2014). Using the hydrogen

bromide as a homogeneous co-catalyst and acetic acid solvent introduces complexity into the pathway due to recycling requirements.

This pathway has an advantage over many others because the downstream processing of GA complements further upgrading to ADA. The GA is purified by gradient chromatography, where the acetic acid concentration in the eluent is varied to separate mono- and dicarboxylic acids in the GA product mixture that forms from catalytic oxidation (Archer et al., 2016; Thaore et al., 2020). This avoids an intermediate purification step aimed at recycling the solvent for chromatography, as the solvent used for ADA production is the same.

2.7. Muconic acid as an intermediate for sugars conversion to adipic acid

Process design and experimentation for ADA production and purification through the intermediate *cis,cis*-muconic acid (CCMA) can be considered the best-described pathway for its production from sugars. Downstream purification methodologies for ADA production from CCMA have been developed for specifically producing ADA at high purity for polymerization to the main industrial product Nylon-6,6 (Vardon et al., 2016).

The CCMA is typically produced from the various feedstock components through biological funneling in an engineered *Pseudomonas putida* strain. Most research has focused on converting lignin hydrolysate or representative lignin monomers to CCMA (Vardon et al., 2015 and 2016; Kohlstedt et al., 2018). However, research has also been conducted on converting a glucose feedstock where titers as high as 59 g/L were reported (Bui et al., 2014) at a yield of 30%. Utilizing mixed sugar feedstocks consisting of glucose and xylose has also been explored, where a molar yield of 46% at a production titer of 33.7 g/L was reported (Ling et al., 2022).

ADA is produced from purified CCMA through catalytic hydrogenation over a metal-carbon catalyst at pressures exceeding 20 bar. The CCMA can be converted to ADA at high yields (97%) by simply removing microbial cells from the fermentation broth (Niu et al., 2002). However, it was shown that without intermediate purification of the CCMA, the micro impurities in the ADA exceeded that of industrial standard for polymerization (Vardon et al., 2016). Hydrogenation of the CCMA was conducted over platinum (Pt), palladium (Pd), and rhodium (Rh) metal catalysts supported on either activated carbon (C) or silica (SiO₂) with yields > 99% (Kohlstedt et al., 2018). It was observed that 1% Rh/C catalysts had the best results for CCMA hydrogenation and stability against metal leaching (Vardon et al., 2016).

2.8. Comparison of sugars-to-adipic acid pathways

The technical specifications of the reported production pathways for converting sugars into ADA are summarized in Table 2, including the overall yields, overall productivities, and final ADA titers, along with the temperatures and pressures of the various conversion steps.

The production of ADA via 5-HMF and GVL risks resulting in expensive and energy-deficient scenarios. The pathway through intermediate 5-HMF has good overall performance parameters, with its overall yield (0.44 g/g sugar) and productivity (9.34 g/L.h) the highest among all the pathways, despite having four conversion steps. The downside to this pathway is the energy-intensive nature of the conversion steps, which leads the pathway to risk having an energy deficit in an energy-self-sufficient biorefinery. The pathway through GVL, on the other hand, has poor production performance compared to the other pathways, with an overall yield and productivity of 0.23g/g sugar and 1.04 g/L.h, respectively, as reported in Table 2. This pathway also suffers from four energy-intensive process conversions and separation techniques that may penalize the economics of 1G and 1G2G scenarios. Because other pathways have fewer processing steps and better process performance and/or are more likely to have lower energy demands, these 5-HMF and GVL pathways were not selected for TEAs. The production of ADA through 1,4-BDO was not investigated further either due to the lack of data on all processing requirements. The conversion of 1,4-BDO to BDDA is a step before ADA production in which experimental conditions and data are lacking, proving it difficult to build rigorous simulations for ADA production.

The direct microbial conversion of sugars to ADA and the pathway with CCMA as an intermediate were in close competition, showing attractive overall yields, volumetric productivities, and final ADA titers (Table 2). The direct pathway produces ADA at a yield, productivity, and ADA titer of 0.5 g/g sugar, 0.18 g/L.h, and 14.9 g/L, respectively. In the CCMA pathway, a lower overall yield of 0.33g/g sugar but higher overall productivity and final ADA titer of

0.14 g/L.h and 59.0 g/L are observed, respectively. The direct pathway has the advantage of a high yield and a single conversion step which would benefit process economics, whereas the CCMA pathway has a lower yield and consists of two conversion steps, presenting a significantly higher ADA titer and overall productivity though. Both pathways were selected for simulations and techno-economic/environmental assessments.

The production of ADA via the intermediate GA is the third pathway selected for further analysis as this pathway has previously reached the pilot plant scale utilizing a pure glucose feed (Skoog et al., 2018) and due to its favorable production parameters. The overall productivity is among the highest of the various pathways at 2.01 g/L.h (Boussie et al., 2016; Lee et al., 2016), as shown in Table 2, and a high ADA production titre (26.0 g/L) has been reported compared to the direct pathway. The pathway consists of only two conversion steps compared to the pathways through 5-HMF and GVL; hence energy efficiency is more plausible.

The ADA production pathway through the intermediate glycerol may result in favorable economics/environmental results due to the low energy-consuming conversion steps and the fact that no intermediate purification is required before ADA production and was therefore chosen for techno-economic/environmental assessments. The pathway does suffer from a low overall yield (0.22 g/g sugar) and low productivity (0.25 g/L.h), as reported in Table 2; however, the titer (57.6 g/L) at which ADA is produced is significantly higher than the other pathways available. This high titre would save significant energy consumption on ADA purification as appose to the direct ADA production pathway.

The pathways selected for TEA and environmental analysis for both the 1G and 1G2G scenario were the direct production pathway and the pathways through intermediates CCMA, GA, and glycerol, referred to as the GLU, CCMA, GA, and GLY scenarios, respectively. These pathways were selected due to their good production parameters, as summarized in Table 2, and because they are most likely to succeed in energy self-sufficient production scenarios annexed an existing sugar mill.

3. Detailed techno-economic and GHG emission comparison

This section comprehensively investigates the techno-economics and GHG emissions associated with four preferred pathways for ADA production. By conducting a detailed comparison, it aims to shed light on the most viable and environmentally sustainable options for ADA manufacturing. Following the initial rigorous analysis, the research evaluates each pathway's economic feasibility, considering factors such as capital investment, operating costs, and overall profitability. Additionally, the environmental impact of these pathways is thoroughly assessed, focusing on GHG emissions to identify potential climate change implications. It is worth mentioning process simulation development is a crucial step for a firm comparison (Nimbani et al., 2021).

3.1. Simulations development

Both 1G and 1G2G self-sufficient biorefinery scenarios, annexed to a typical South African sugar mill, were simulated in AspenPlus® V11 software for the four selected pathways, i.e., direct microbial conversion of sugars to ADA, or ADA production through one of the intermediates, CCMA, GA and GLY. For each of the four scenarios, it was assumed that the sugar mill had a cane crushing capacity of 300 t/h, which resulted in the production of 25.4 t/h of A-molasses (1G feedstock) and 90 t/h of bagasse (2G feedstock) (Dogbe et al., 2020). It was also assumed that green harvesting techniques are implemented in sugarcane agriculture, making an additional 22.5 t/h of harvest residues in the form of brown leaf lignocelluloses available to the biorefinery (Farzad et al., 2017). The assumed compositions for the A-molasses (Dogbe et al., 2020) and lignocellulosic (Nimbani et al., 2021) feedstocks were the same as reported previously, as well as the AspenPlus® specifications for the complex biopolymers, extractives, and sugars found in the available feedstock (Humbird et al., 2011).

Energy self-sufficiency for the sugar mill and biorefinery complex was achieved in the 1G scenarios by supplying enough bagasse and brown leaves to the existing sugar mill boiler and a new, supplementary medium-pressure boiler if required (Dogbe et al., 2020). In the 1G2G scenarios where both 1G and 2G feedstocks are converted into ADA, a portion of the

Table 2.

Overall comparison of ADA production pathway process parameters based on the assumption that A-molasses feedstock can be utilized similarly to pure, simple sugar feedstocks.

Pathway step conversion description	Step conversion method	Possible feedstock	C _{ADA} (g/L)	Overall production parameters		Process specifications		Reference
				Y _{overall} (g/g sugar)	Q _{overall} (g/L.h)	Step temperature (°C)	Step pressure (bar)	
(1) GLU → ADA	(1) Biological	Glucose Fructose	14.9	0.50	0.18	(1) 30	–	Zhao et al. (2018)
(1) Sugar → HMF (2) HMF → FDCA (3) FDCA → THFDCA (4) THFDCA → ADA	(1) – (2) Oxidation (3) Hydrogenation (4) –	Fructose Glucose Cellulose	31.5	0.44	9.34	(1) 180 (2) 100 (3) 140 (4) 160	(1) – (2) 40 (3) 52 (H ₂) (4) 50 (H ₂)	Buntara et al. (2011); Boussie et al. (2014); Beerthuis et al. (2015)
(1) GLU → CCMA (2) CCMA → ADA	(1) Biological (2) Hydrogenation	Sucrose Glucose Fructose Xylose	59.0	0.33	0.41	(1) 37 (2) 78	(1) – (2) 34 (H ₂)	Davis et al. (2018); Bui et al. (2014)
(1) GLU → 1,4-BDO (2) 1,4-BDO → ADA	(1) Biological (2) Carbonylation	Glucose Sucrose Cellulosic biomass sugars	–	0.30	3.83	(1) 30 (2) 175	(1) – (2) 49 (CO)	Barton et al. (2015); Beerthuis et al. (2015)
(1) GLU → GA (2) GA → ADA	(1) Oxidation (2) Hydrodeoxygenation	Glucose	26.0	0.23	2.01	(1) 80 (2) 160	(1) 13.8 (O ₂) (2) 50	Boussie et al. (2014); Lee et al. (2016)
(1) SUGAR → LA (2) LA → GVL (3) GVL → PAI (4) PAI → ADA	(1) – (2) Hydrogenation (3) Reactive distillation (4) Hydrocarbonylation	Sucrose Glucose Fructose Cellulose Hemicellulose	314.0	0.23	1.04	(1) 100 – 170 (2) 200 (3) 220 (4) 100	(1) 35 (2) 50 (3) – (4) 30 (CO)	Alonso et al. (2013a); Nobbs et al. (2016)
(1) GLU → GLY (2) GLY → ADA	(1) Biological (2) Biological	Glucose Molasses	57.6	0.22	0.25	(1) 30 (2) 31	–	Overkamp et al. (2002); Zhou et al. (2020)

Y: yield, Q: productivity; GLU: glucose; 1,4-BDO: 1,4-Butanediol; CCMA: cis,cis-muconic acid; HMF: 5-hydroxymethylfurfural; FDCA: 2,5-furandicarboxylic acid; THFDCA: tetrahydrofuran-2,5-dicarboxylic acid; GLY: glycerol; GA: gluconic acid; LA: levulinic acid; GVL: γ -valerolactone; PAI: pentanoic acid isomers.

2G feedstock, referred to as the "bypass", is fed directly to a new combined heat and power plant (CHP) (Ratshoshi et al., 2021) to provide energy self-sufficiency. This bypass is optimized to maximize the amount of ADA produced while maintaining energy self-sufficiency for the biorefinery and sugar mill operations (Nimbani et al., 2021).

In the 1G2G ADA scenarios, the lignocellulosic feedstock was treated with dilute acid pretreatment (DAT) and enzymatic hydrolysis to unlock glucose and xylose sugars based on a reported design (Humbird et al., 2011) and with conversion data for the maximum combined sugar yield from lignocelluloses (Nieder-Heitmann et al., 2019).

The feed strategy used in all the 1G and 1G2G scenarios was similar. In the 1G scenarios, A-molasses underwent sterilization, inversion if required, and dilution before being fed to the corresponding fermenter or catalytic reactor (Moonsamy et al., 2022). In scenarios where only glucose could be utilized, the fructose was assumed to remain inert. In the 1G2G scenarios, the lignocellulose hydrolysate was mixed with A-molasses before being fed to the fermenter or catalytic reactor. In scenarios where one of the simple sugars could not be utilized, they were conveyed to the biological wastewater treatment (WWT) facility for biogas production simulated through previously published specifications (Steinwinder et al., 2011).

3.1.1. Adipic acid production via direct microbial conversion of sugars

In the 1G direct ADA production scenario, A-molasses was fed to the ADA fermenter after sterilization, inversion, and dilution. The glucose fraction of A-molasses has been proven to be converted to ADA by *E. coli* (Zhao et al., 2018; Zhou et al., 2020), and it was assumed that fructose could be converted similarly without catabolite repression (Andersson et al., 2007). To maximize

the feedstock supplied, sucrose underwent enzymatic sugar inversion after sterilization at 110 °C (Overkamp et al., 2002). The sugar feedstock was finally diluted to a sugar content of 40.5 g/L before being fed to the ADA fermenter, as indicated in Figure 3.

The sugar feed produced in the 1G and 1G2G scenarios produced ADA at a concentration of 15 g/L (Zhao et al., 2018) and a yield of 0.378 g ADA/g glucose. The highest achieved ADA yield on a glucose substrate was 93.1% of the theoretical yield in a shake flask (Zhao et al., 2018). At larger production scales, this value is generally seen as lower; therefore, it was assumed that the yield achievable would only be 70% of the theoretical as was observed for ADA production on a glycerol substrate in a 5 L batch-fed fermenter (Zhou et al., 2020). A chain of seed reactors was used to produce the starting amount of *E. coli* for ADA production by utilizing a small fraction of the sugar feedstock.

The fermentation was operated under neutral pH by adding an ammonium hydroxide base (Gunukula and Anex, 2017), assuming that ADA dissociates fully to form diammonium adipate. The filtration eluent, containing the desired product diammonium adipate and byproduct ammonium acetate, was further purified through multi-effect vacuum evaporation (MEV) and reactive distillation (Fruchey et al., 2011), as seen in Figure 3. A four-effect MEV starting at a temperature and pressure of 86 °C and 0.6 bar with a 1.5 pressure ratio drop in each effect (Aden et al., 2002) concentrated diammonium adipate to a 10 wt% stream fed to reactive distillation. Reactive distillation was operated at a 2 bar and 129 °C that produced ADA by removal of ammonia (Fruchey et al., 2011). The ADA crystals were obtained through cooling crystallization (Davis et al., 2018), centrifugation, and rotary vacuum drying (Silva-Moris and Rocha, 2006; Gunukula and Anex, 2017).

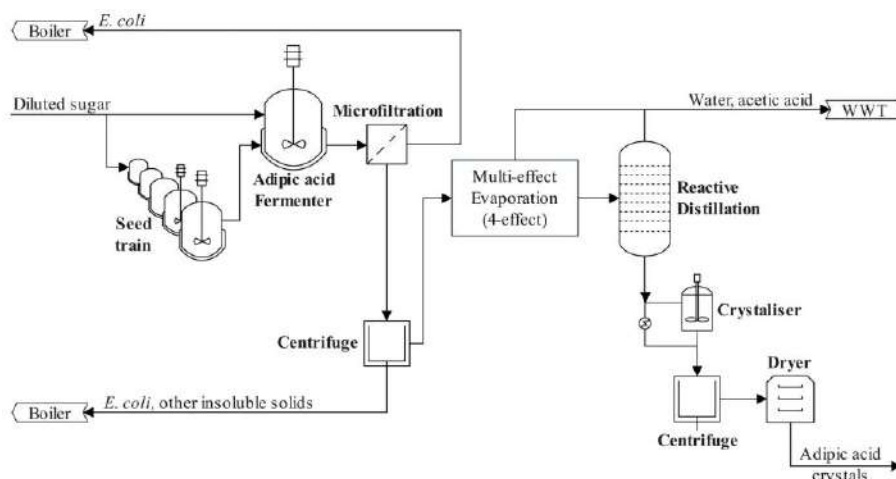

Fig. 3. Adipic Simplified process flow diagram of the direct adipic acid pathway scenario.

3.1.2. Adipic acid production via glycerol as intermediate

The ADA production process through the intermediate glycerol was similar to the direct ADA process in Figure 4, except that MEV was not required, and glycerol was produced before its conversion to ADA. Glycerol was produced at a yield of 0.51 g/g sugars fed and a concentration of 219 g/L on the fermentation specifications previously reported for *S. cerevisiae* with no byproduct production (Overkamp et al., 2002). It was assumed that fructose and sucrose would be converted to glycerol in a manner similar to glucose (Kalle and Naik, 1986; Munene et al., 2002). Initial fermenter microbial biomass was produced in a series of reactors utilizing a fraction of the sugar feed stream. It was assumed that *S. cerevisiae* could be recycled up to eight times before a new yeast inoculum should be produced. After microfiltration of the fermentation broth, the glycerol-rich stream was diluted to 80 g/L (Zhao et al., 2018) and fed to the ADA-producing fermenters.

carbon column at 2% (w/v) to remove the 5-HMF and furfural impurities (Nieder-Heitmann et al., 2019a) before mixing with the A-molasses and lignocellulosic hydrolysate.

The CCMA was recovered from the fermentation broth by acidification and crystallization before dissolution in an ethanol solvent for further conversion to ADA (Davis et al., 2018). Crystallization followed by dissolution was required to remove minor impurities such as iron and nitrogen-containing compounds from CCMA crystals due to the purity specification of ADA for polymer production (Vardon et al., 2016). After that, the CCMA was upgraded to ADA in the ethanol solvent and recovered via crystallization, centrifugation, and drying. The hydrodeoxygenation reaction occurs over an Rh/C catalyst at 78 °C and 40.5 bar to produce ADA at a molar yield of 100% (Davis et al., 2018). The ethanol was recovered through evaporation resulting in an ethanol-ADA ratio of 2.5, which was conveyed to crystallization to recover ADA crystals (Davis et al., 2018).

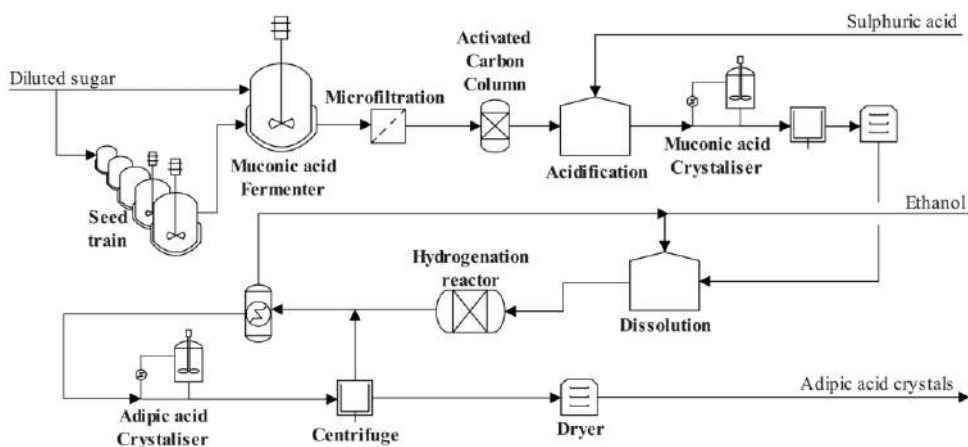

Fig. 4. Simplified process flow diagram to produce adipic acid via the intermediate muconic acid.

3.1.3. Adipic acid production via intermediate cis,cis-muconic acid

The ADA production process via CCMA as intermediate, as displayed in Figure 4, was designed based on the process for ADA production from lignin described previously (Davis et al., 2018). It was assumed that all the simple sugars (i.e., glucose, fructose, sucrose, and xylose) would be consumed to the same extent (Davis et al., 2018) to produce CCMA at a molar yield of 54%. In the 1G2G scenario, the xylose fraction was passed through a granular activated

3.1.4. Adipic acid production via intermediate glucaric acid

It was assumed that GA could be produced from an impure glucose feed stream such as A-molasses (1G) or the combination of A-molasses with the lignocellulose hydrolysate (1G2G) and that the non-glucose sugars (Jin et al., 2016; Derrien et al., 2017) and impurities (Gunukula and Anex, 2017) would remain inert without affecting the reaction outcome. Producing pure glucose and a pure fructose stream already results in two valuable products

that may render further upgrading futile, thus requiring the assumption of inert non-glucose sugars to be verified experimentally in the future.

The 1G-only or combined 1G2G feed streams, both diluted such that a final sugar concentration of 50 wt% was achieved (Kapanji et al., 2019), were fed to continuously stirred tank reactors (Gunukula and Anex, 2017) and converted to GA at a 73% molar yield (Fig. 5) over a platinum-carbon (Pt/C) catalyst (Lee et al., 2016). The reactor was operated at a temperature of 80 °C and 13.8 bar with no pH control (Lee et al., 2016). Under these reaction conditions, gluconic acid (Lee et al., 2016), arabinonic acid, and formic acid (Dirkx et al., 1977) were assumed to form as byproducts. The reactor product was centrifuged to recover and recycle the Pt/C catalyst.

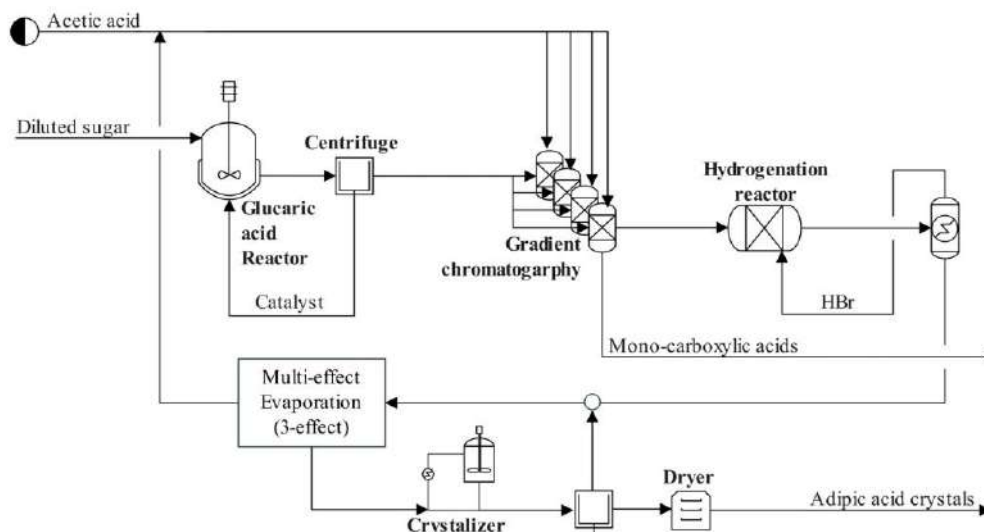

Fig. 5. Simplified production process of the adipic acid through the intermediate glucaric acid scenario.

The reactor product containing GA, the various byproducts, and unconverted sugars was purified through gradient chromatography before further conversion to ADA (Fig. 5). The GA was recovered through the chromatography process specified elsewhere (Archer et al., 2016; Thaore et al., 2020) utilizing an acetic acid-water eluent. The pure GA was then upgraded to ADA through catalytic hydrogenation over a bimetallic catalyst (platinum-rhodium/Pt-Rh) at 160 °C and 50 bar (Boussie et al., 2014) in an acetic acid water solvent to produce ADA at a molar yield of 86% (Boussie et al., 2016). Before being fed to the hydrogenation reactor, the homogeneous hydrogen bromide (HBr) promoter was mixed with the GA feed at a molar ratio of 1:1 to GA (Boussie et al., 2014). The HBr was recovered and recycled back to the hydrogenation reactor through evaporation under the specification that at least 90% of the HBr would be recovered.

Before final ADA recovery through cooling crystallization (Davis et al., 2018), centrifugation, and drying (Silva-Moris and Rocha, 2006; Gunukula and Anex, 2017), the acetic acid water solvent is recovered through MEV and recycled back to gradient chromatography. The three-effect MEV was operated at a starting pressure of 0.6 bar with a 1.5 pressure ratio drop in subsequent effects (Aden et al., 2002) to recover 80% of the acetic acid in the feed stream. After centrifugation of the ADA crystals, the liquid effluent was recycled back to the MEV to optimize the recovery of ADA and the acetic acid solvent.

3.2. Economic assumptions

A real-term discounted cash flow analysis was conducted for each scenario to determine the MSP of ADA to achieve the desired internal rate of return of 20% (real terms) over a plant life of 25 yr. The other assumptions included in the discounted cash flow analysis are the same as previously published work except that the costing year was 2019, and the start-up time was one year (Ratshoshi et al., 2021). The MSPs for ADA in the various scenarios were compared to the fossil-based ADA selling price in 2020 of USD 2,198/metric

tonne (Mt) (Grand View Research, 2021). The mass and energy balance data obtained from the ADA simulations were used to estimate the equipment sizes and determine the purchase costs as described elsewhere, as well as the Aspen Plus® Economic evaluator (Ratshoshi et al., 2021). The OPEX consisted of variable operating costs such as raw materials, waste, and feedstock and fixed operating costs such as labor, maintenance, and taxes (Humbird et al., 2011).

The cost of A-molasses was determined as the sum of losses made due to the reduced production of crystalline sucrose and no production of C-molasses from the sugar mill and was estimated to be USD 193.9/Mt

(Ratshoshi et al., 2021). The total amount of crystalline sucrose lost to the A-molasses is 10.7 t/h, which was USD 303.0/Mt (OECD/FAO, 2019). The 11.57 t/h C-molasses, which would have been produced as a byproduct, is valued at USD 145.7/Mt (Dogbe et al., 2020). The bagasse feedstock cost was taken as USD 29.6/Mt, which was determined based on its heating value relative to coal, whereas the cost of trash (USD 31.6/Mt) was based on its collection cost (Dogbe et al., 2018).

3.3. Greenhouse gas emissions

Cradle-to-gate GHG (Brandão et al., 2022) emission estimates were conducted using version 2.13 of the RSB calculator tool using the RBS Global Certification methodology (<https://rsb.org/services-products/ghg-calculator/>). The system boundary of the analysis includes the feedstock cultivation, the sugar mill, the biorefinery, and the existing unit in 1G scenarios and the new CHP unit in the 1G2G scenarios. Within the RSB tool, the processing steps were split into two system boundaries: processing one, which involves the sugar mill, and processing two, which encompasses the entire biorefinery except for the CHP units. Burning bagasse, brown leaves, biogas, and microbial biomass were assumed to lead to biogenic carbon generation. The system boundaries and their inputs and outputs are summarized in Figure S3 (Supplementary file), and the feedstock cultivation data used are provided in Table S1 (Supplementary file).

3.4. Performance comparison

In the following, the results of comparing techno-economics and GHG emissions of the four preferred biobased pathways for ADA are discussed in detail. Overall, mass and energy balances have a pivotal role in economics and GHG emissions comparison.

3.4.1. Mass and energy balances

The mass and energy balance results in **Table 3** demonstrate that the 1G2G CCMA scenario had the highest production rate (73.6 kMt/yr) among all scenarios investigated. This was because all the simple sugars obtainable from the 2G feedstock could be utilized and because of the low energy demand of this pathway in an energy-self-sufficient biorefinery configuration.

The CCMA scenarios followed by the GA scenarios were the most energy efficient among the investigated pathways, with the lowest heating requirement per unit ADA produced. The heating requirement in the 1G CCMA scenario was 1.3 MW/Mt ADA and 3.1 MW/Mt ADA in the 1G GA, as reported in **Table 3**.

Table 3.
Mass and energy balance results for 1G and 1G2G scenarios.

	Scenarios							
	CCMA		GA		GLU		GLY	
	1G	1G2G	1G	1G2G	1G	1G2G	1G	1G2G
<i>Feed Flow:</i>								
1G Feedstock (Mt/h)	25.4	25.4	25.4	25.4	25.4	25.4	25.4	25.4
2G Feedstock – wet basis (Mt/h)	-	113.5	-	113.5	-	23.8	-	54.5
Simple sugars available for conversion (Mt/h)	19.8	44.4	10.2	26.8	20.2	23.9	20.2	28.1
Production rate (kMt/yr)	30.7	73.6	23.5	61.8	38.6	44.2	20.3	27.0
<i>Utilities:</i>								
Bypass ratio	-	-	-	-	-	0.8	-	0.5
Steam demand [†] (MW/Mt ADA)	1.3	3.0	3.1	4.3	10.9	12.4	10.2	15.8
Cooling demand (MW/Mt ADA)	3.1	4.1	4.8	5.3	8.8	10.5	8.6	11.0

Unlike the 1G CCMA and 1G GA scenarios, poor energy efficiency was observed for the 1G GLU and 1G GLY scenarios. The ADA purification (ADAPUR) area accounted for 89% of the total high specific energy demand of the 1G GLU scenario (10.9 MW/Mt ADA) (**Table 3**) due to the low ADA product titer of 15 g/L compared to 50 g/L previously used for direct ADA production (Gunukula and Anex, 2017). This low titer resulted in the need to remove large amounts of water through MEV and reactive distillation. In fact, the ADAPUR area in all scenarios was the primary consumer of all utilities required, as demonstrated by the heat map (**Table S2, Supplementary file**). In the 1G GLY scenario, there was an improvement in the ADA titer (60 g/L); however, the overall yield was low (0.20 g/g simple sugars) in comparison to the 1G GLU scenario (0.5 g/g simple sugars). Due to this low yield, the 1G GLY scenarios had a high specific heating demand of 10.2 MW/Mt ADA.

The low energy demand observed in the 1G CCMA and 1G GA scenarios was also translated into more successful 1G2G biorefineries. The energy supply constraints in energy-self-sufficient biorefineries are alleviated in more energy-efficient processes (Ratshoshi et al., 2021), requiring a smaller portion of the 2G feedstock for energy production. With less feedstock used to meet energy requirements, more can be used to produce ADA leading to higher economies of scale benefits. The energy demand of the 1G2G CCMA and 1G2G GA scenarios recorded in **Table 3** are 3.0 and 4.3 MW/Mt ADA, which resulted in the production of 73.6 and 61.8 kMt/yr of ADA, respectively, which was significantly higher than the 1G scenarios in which the highest production was achieved by the 1G GLU scenario (38.6 kMt/yr). These were the 1G2G scenarios where the most ADA was produced partially because no bypass was required for energy production. Hence, as previously observed, low energy demand in the 1G2G scenarios is related to higher production rates in these energy-self-sufficient scenarios (Ratshoshi et al., 2021).

The zero-bypass required for the 1G2G CCMA and 1G2G GA scenarios was because of the additional CHP fuel supplies produced as byproducts by these two scenarios. Additional microbial biomass (1.9 t/h) and biogas (3.6 t/h) produced in the 1G2G CCMA scenario was enough additional fuel along with the lignin fraction of the lignocellulose feedstock to operate the new CHP to supply the low steam demand of 3.0 MW/Mt ADA (44.0 MW) reported in **Table 3**. In the 1G2G GA scenario, significantly more biogas was produced because, beyond the xylose fraction from the lignocellulosic feedstock, the fructose fraction of A-molasses was also conveyed to WWT to produce biogas. Since it was assumed that the fructose would not disturb GA production and remain unconverted, it was treated through anaerobic digestion, resulting in a significant amount of biogas. Of this biogas, 11.4 t/h was used as an additional fuel source along with the lignin from the 2G feedstock to supply the required heat demand of the sugar mill as well as the 4.3 MW/Mt ADA (53.0 MW) of the biorefinery (**Table 3**).

The energy intensiveness of the 1G GLU and 1G GLY scenarios was translated into high bypass ratios in 1G2G GLU and 1G2G GLY scenarios. The bypass ratios in the 1G2G GLU and 1G2G GLY scenarios were 0.8 and 0.5, respectively. This is significantly higher than the zero-bypass observed for the 1G2G CCMA and 1G2G GA scenarios (**Table 3**). The GLU and GLY scenarios require energy-intensive ADAPUR techniques such as MEV and reactive distillations. This was translated into more of the lignocellulosic feedstock to be used as an energy source, especially in the 1G2G GLU scenario due to the low ADA titer (15 g/L). However, one can see an improvement in the energy intensity between the 1G2G GLU and 1G2G GLY scenarios due to the improvement in the titer of ADA (60 g/L). It has been shown that the direct pathway to ADA production would not be economically viable if the ADA concentration were below 25 g/L (Gunukula and Anex, 2017), which could be attributed to the high energy demand of ADA purification and low ADA recovery.

3.4.2. Economics

The economic results in terms of the total capital investment (TCI), fixed operating cost, variable, and MSP are listed in **Table 4**. The breakdown of the specific TCI (USD/t.yr) per processing area is illustrated in **Figure 6**.

Table 4.
Economic results of adipic acid production scenarios

Pathway	Scenario	TCI ^a (MUSD)	Fixed OPEX ^b (USD/Mt)	Variable OPEX (USD/Mt)	MSP ^c (USD/Mt)
CCMA	1G	102	108	1 464	2 538
	1G2G	521	95	1 260	3 288
GA	1G	45	128	2 209	3 109
	1G2G	385	94	2 296	4 249
GLU	1G	163	109	1 630	2 932
	1G2G	366	138	1 592	3 878
GLY	1G	90	157	2 046	3 488
	1G2G	349	233	1 540	5 115

^a Total capital investment in million USD.

^b Operating expenditure in USD/Mt.

^c Minimum selling price of adipic acid.

The 1G CCMA scenario produced the lowest ADA MSP of USD 2,547/Mt, primarily due to the low energy demand of the scenario and lower capital investment compared to the nearest alternative, i.e., the 1G GLU scenario with an MSP of USD 2,932/Mt. One would typically expect the scenario with the fewest processing steps to be the better-performing scenario, which in this case would have been the 1G GLU scenario, but the two-step conversion in the 1G CCMA scenario performed better.

The energy requirement in energy-self-sufficient scenarios significantly impacts economic success (Ratshoshi et al., 2021). A higher energy demand resulted in a higher MSP, as was observed here (**Fig. S4, Supplementary file**). The 1G CCMA scenario had a low energy requirement (1.3 MW/Mt), whereas the 1G GLU scenario had a significantly higher energy demand (10.2 MW/Mt). This high energy demand resulted in the need for an

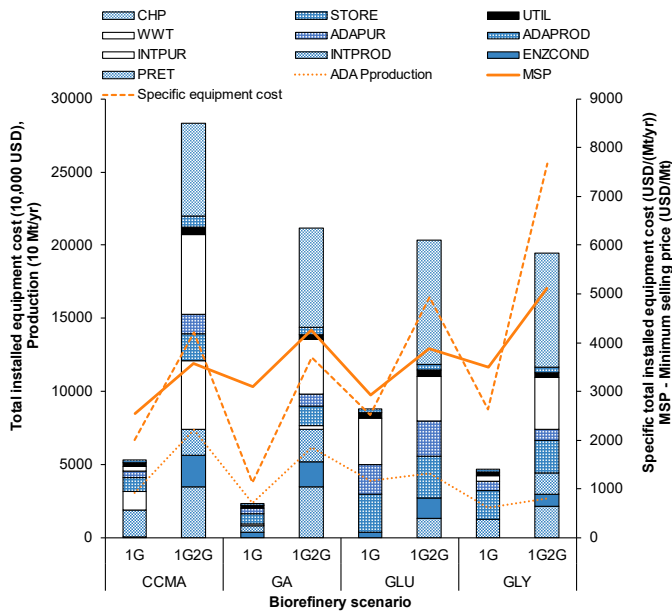

Fig. 6. Capital cost breakdown per processing area compared to specific installed equipment cost and minimum selling price (MSP). CHP: Combined heat and power plant, STORE: Storage, UTIL: Utilities, WWT: Wastewater treatment, ADAPUR: Adipic acid purification, ADAPROD: Adipic acid production, INTPROD: Intermediate production, INTPUR: Intermediate purification, ENZCOND: Enzymatic hydrolysis and feed conditioning, PRET: Pretreatment, ADA: Adipic acid.

additional MPB responsible for USD 225/Mt of the variable OPEX of the 1G GLU scenario (USD 1,630/Mt) reported in [Table 4](#).

Technical improvement is required on the titer at which ADA is produced in the direct production pathway (GLU) to improve economic performance but not at the expense of productivity and yield. The low ADA production titer was the main cause for poor economic performance because of the high installed cost it inferred on the WWT area and the ADAPUR area. The installed cost of the WWT area of the 1G GLU (MUSD 32.2) was nearly 10 times more than the other 1G scenarios ([Fig. 6](#)) because of the increased volume of wastewater produced. When comparing the cost of the ADAPUR area of the 1G GLU scenario (MUSD 20.3) with the corresponding 1G GLY scenario (1G – MUSD 6.4) in [Figure 6](#), there is a significant drop in the installed cost. This was due to the increased volume requiring purification due to the low titer of ADA in the 1G GLU scenario (16 g/L) compared to the 1G GLY scenario (60 g/L). This result agrees with the previous TEA on the direct production of ADA, where it was concluded that exponential variation was observed in the MSP of ADA when titers fell below 50 g/L ([Gunukula and Anex, 2017](#)).

Even though the GLY pathway had better performance in terms of the installed cost associated with WWT and ADAPUR in the 1G and 1G2G scenario compared to the GLU pathway, it was still the worst-performing pathway because of its low overall mass yield (20%). The MSPs of the 1G and 1G2G GLY scenarios were USD 3,488/Mt and USD 5,115/Mt, respectively, where the 1G2G GLY scenario had the highest MSP among all scenarios. The theoretical yield of glycerol on a sugar feedstock has reportedly reached as high as a titer of 219 g/L, and a productivity of 2.4 g/L.h ([Overkamp et al., 2002](#)), hence there are very limited potential for improvement of this pathway. However, this pathway could be considered for the ethanol industry to upgrade the low-value glycerol byproduct to ADA.

Economies of scale benefits are seen for the 1G CCMA scenario due to its high overall yield on the available feedstock compared to the 1G GA and 1G GLY scenarios and its higher productivity and titer compared to the 1G GLU scenario. The 1G GA scenario had the lowest CAPEX (MUSD 45.0), followed by the 1G GLY (MUSD 89.6), 1G CCMA (MUSD 102.2), and finally, the 1G GLU (MUSD 162.8) scenario as tabulated in [Table 4](#). The 1G GA scenario was the only scenario that had a lower specific installed equipment cost (USD 989/Mt.yr) compared to the 1G CCMA scenario (USD 1,727/Mt.yr), as

seen in [Figure 6](#); however, the CCMA scenario had the lowest MSP due to the increased production of ADA.

The 1G2G scenarios were significantly more CAPEX-intensive than the 1G scenarios; however, economies of scale benefits are seen for the 1G2G CCMA and 1G2G GA scenarios. The specific TCI increased 5 and 8 times for the 1G2G CCMA and 1G2G GA scenarios from the 1G scenarios, respectively; however, the MSP of ADA only increased by 1.3 and 1.4, respectively ([Table 4](#)). This was achieved due to the increase in production capacity from the 1G scenarios ([Table 3](#)).

3.4.3. Environmental impacts

The feedstock cultivation process contributed significantly to the GHG emissions in all the scenarios. This is typically observed in biorefinery scenarios due to the nitrogen fertilizers used in cultivation stages ([Farzad et al., 2017](#)). In the scenarios investigated, feedstock cultivation contributed 25% to 53% of the total GHG emissions, as summarized in [Figure 7](#).

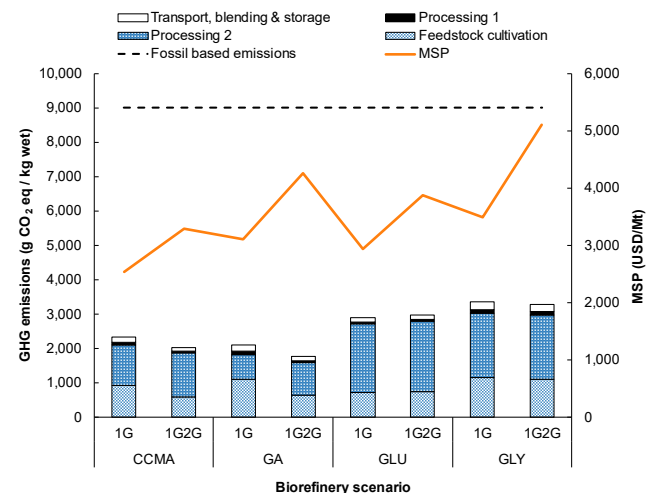

Fig. 7. GHG emissions associated with the various ADA biorefinery scenarios compared to the corresponding minimum selling prices (MSPs) and the fossil-based ADA emissions for the United States in 2017 ([Flederbach and Winch, 2019](#)) in terms of g CO₂ eq/kg wet product.

Compared to fossil-based ADA production, the emissions from the biorefinery scenarios are significantly lower than fossil-based ADA due to the omission of nitrous oxide production and the use of agricultural feedstock. The GHG emissions from the biorefinery scenarios range between 1,758 and 3,349 g CO₂ eq/kg wet ([Fig. 7](#)), whereas the GHG emissions of fossil-based ADA facilities in the United States were previously determined to be 9,024 g CO₂ eq/kg wet in 2017 ([Flederbach and Winch, 2019](#)). The primary reason for such high GHG emissions would be nitrous oxide production ([Skooq et al. 2018; Flederbach and Winch, 2019](#)).

The 1G CCMA scenario had the best overall performance in terms of economics and environmental indicators, even though the 1G2G GA scenario had the lowest GHG emissions (1,758 g CO₂ eq/kg wet). The 1G CCMA scenario provided the lowest MSP (USD 2,538/t) with 74% lower emissions than fossil-based ADA production, as summarized in [Figure 7](#). The 1G2G GA scenario on the other hand, had the second highest MSP (USD 4,249/t); therefore, a better trade-off between economics and environmental performance is observed for 1G CCMA.

Depending on the improvement that can be made to the titer at which ADA is produced in the 1G GLU scenario, the preferred pathway should be re-evaluated. With current advances, the MSP of the 1G GLU scenario (USD 2,932/t) is USD 394/t more than the 1G CCMA scenario and provides lower GHG emissions (2,909 g CO₂ eq/kg wet) compared to fossil-based ADA production yet higher than the 1G CCMA scenario (2,325 g CO₂ eq/kg wet) as indicated in [Figure 7](#). If a titer greater than 25 g/L ([Gunukula and Anex, 2017](#)) could be achieved, the MSP of the 1G

GLU scenario might fall below that of the 1G CCMA scenario, which might be more attractive to investors. However, further research is required to determine the effect of production parameters on the MSP and GHG emissions of these two scenarios. Therefore, a full life cycle analysis (LCA) (Gheewala, 2023) should be done to investigate the impact of other environmental impact categories.

4. Policy and practical implications of the present study

From a policy implications point of view, adopting biobased ADA production annexed to a sugar mill is well aligned with global efforts to mitigate climate change and reduce GHG emissions. At a governmental level, some regulations and policies, such as carbon pricing mechanisms, renewable energy subsidies, and tax credits for businesses transitioning to sustainable production practices, can incentivize this integration adoption. Furthermore, integrating ADA production with a sugar mill fosters a circular economy model (Fazzino et al., 2023). Using sugar mill byproducts, such as bagasse and molasses, as feedstock for ADA production minimizes waste and enhances resource efficiency. Policymakers can encourage circular economy initiatives through regulatory support, funding opportunities, and awareness campaigns. Furthermore, policymakers can facilitate this development by investing in research and development, providing grants for pilot projects, and creating supportive regulatory frameworks that foster biobased innovation.

It is worth mentioning that based on the present study's findings, there are some other practical implications requiring attention to technological advancements, supply chain management, and market penetration. Successful integration requires advances in biotechnological processes to convert biomass feedstock into ADA efficiently and economically. In addition, an integrated biobased ADA production system necessitates efficient supply chain management. Collaboration between sugar mills, chemical manufacturers, and logistics providers becomes critical to ensure a seamless flow of feedstock and product distribution (Gheewala, 2023). Finally, adopting biobased ADA faces competition from the well-established petrochemical-based ADA market. Marketing efforts, quality assurance, and price competitiveness are vital to gaining market share and consumer acceptance.

5. Conclusions and future perspectives

Technical screening of the available biobased ADA production pathways utilizing biomass-derived sugars revealed that significant research is still required on ADAPUR strategies and integration. ADAPUR was a utility hotspot in many scenarios due to energy-intensive purification strategies. In addition, multi-step energy-intensive pathways for ADA production will not work for energy self-sufficient scenarios due to limited feedstock to supply the energy demand, even if overall production performance parameters are high. Between the scenarios investigated, a high MSP was related to high energy consumption.

Detailed simulations were constructed for pathways with the best technical performance for energy-self-sufficient biorefinery scenarios that were feedstock limited, utilizing A-molasses (1G scenario) and a combination of A-molasses and lignocellulosic biomass (1G2G scenario). The 1G CCMA pathway currently provides the best alternative biobased ADA production route based on the relationship between its economic feasibility and environmental impact. This scenario resulted in the lowest MSP among all investigated scenarios due to its low energy consumption and good overall production parameters. It also showed much lower GHG emissions compared to fossil-based ADA production.

Further investigation on the impact of improved production parameters, specifically ADA titer, on the economics and GHG emissions of the 1G GLU scenario is required to determine at what point this scenario would outperform the 1G CCMA scenario. A high energy requirement and the large volume of wastewater were the consequences of a low ADA titre which negatively impacted the economic feasibility of the process. Furthermore, future work could investigate comparing ADA production pathways in standalone facilities where energy consumption is not penalized as severely as in energy-self-sufficient scenarios. Further consideration should also be given to ADA production through the 1,4-BDO pathway, especially due to its good overall production parameters compared to the other scenarios. Finally, a full LCA should be done investigating the impact of other environmental impact categories.

In a broader context, the integration of biobased ADA production with a sugar mill holds promise as a sustainable and environmentally friendly alternative to traditional petrochemical-based methods. To realize its full potential, policymakers must implement supportive regulations, promote a circular economy, and invest in research and development. Practical challenges such as technological advancements and supply chain management must also be addressed to facilitate the successful adoption of this innovative approach.

Acknowledgements

The author sincerely acknowledges the financial support provided by National Research Foundation (NRF) to complete the project under grant No. MND210815631635. We acknowledge Aspen Technology Inc. for providing Aspen Plus® academic licenses to conduct the process flow simulations. Aspen Plus® is a registered trademark of Aspen Technology Inc. Finally, acknowledgment is given to the Roundtable on Sustainable Biomaterials (RSB) for providing the RSB GHG calculator tool to participating members, operators, and students.

References

- [1] Aden, A., Ruth, M., Ibsen, K., Jechura, J., Neeves, K., Sheehan, J., Wallace, B., Montague, L., Slayton, A., Lukas, J., 2002. Lignocellulosic biomass to ethanol process design and economics utilizing co-current dilute acid prehydrolysis and enzymatic hydrolysis for corn stover. National Renewable Energy Laboratory, (NREL), Golden, United States.
- [2] Alonso, D.M., Wettstein, S.G., Dumesic, J.A., 2013a. Gamma-valerolactone, a sustainable platform molecule derived from lignocellulosic biomass. *Green Chem.* 15(3), 584-595.
- [3] Alonso, D.M., Wettstein, S.G., Mellmer, M.A., Gurbuz, E.I., Dumesic, J.A., 2013b. Integrated conversion of hemicellulose and cellulose from lignocellulosic biomass. *Energy Environ. Sci.* 6(1), 76-80.
- [4] Andersson, C., Hodge, D., Berglund, K.A., Rova, U., 2007. Effect of different carbon sources on the production of succinic acid using metabolically engineered *Escherichia coli*. *Biotechnol. Prog.* 23(2), 381-388.
- [5] Archer, R., Diamond, G.M., Dias, E.L., Murphy, V.J., Petro, M., Super, J.D., 2016. Process for the separation of mono- and dicarboxylic acid compounds. U.S. Patent 9,487,465B2.
- [6] Babu, T., Yun, E.J., Kim, S., Kim, D.H., Liu, K.H., Kim, S.R., Kim, K.H., 2015. Engineering *Escherichia coli* for the production of adipic acid through the reversed β -oxidation pathway. *Process Biochem.* 50(12), 2066-2071.
- [7] Barton, N.R., Burgard, A.P., Burk, M.J., Crater, J.S., Osterhout, R.E., Pharkya, P., Steer, B.A., Sun, J., Trawick, J.D., Van Dien, S.J., Yang, T.H., Yim, H., 2015. An integrated biotechnology platform for developing sustainable chemical processes. *J. Ind. Microbiol. Biotechnol.* 42(3), 349-360.
- [8] Beerthuis, R., Rothenberg, G., Shiju, N.R., 2015. Catalytic routes towards acrylic acid, adipic acid and ϵ -caprolactam starting from biorenewables. *Green Chem.* 17(3), 1341-1361.
- [9] Boussie, T.R., Diamond, G.M., Dias, E., Murphy, V., 2016. Synthesis of adipic acid starting from renewable raw materials, in: Cavani, F., Albonetti, S., Basile, F., Gandini, A. (Eds.), *Chemicals and Fuels from Bio-Based Building Blocks*. Wiley-VCH Verlag GmbH & Co. KGaA, pp. 151-172.
- [10] Boussie, T.R., Dias, E.L., Fresco, Z.M., Murphy, V.J., Shoemaker, J., Archer, R., Jiang, H., 2014. Production of adipic acid and derivatives from carbohydrate-containing materials. Patent US20100317823A1.
- [11] Brandão, M., Heijungs, R., Cowie, A.R., 2022. On quantifying sources of uncertainty in the carbon footprint of biofuels: crop/feedstock, LCA modelling approach, land-use change, and GHG metrics. *Biofuel Res. J.* 9(2), 1608-1616.
- [12] Bui, V., Lau, M.K., MacRae, D., Schweitzer, D., Amyris Inc, 2014. Methods for the producing isomers of muconic acid and muconate salt. U.S. Patent 8,809,583B2.

- [13] Buntara, T., Noel, S., Phua, P.H., Meliun-cabrera, I., de Vries, J.G., Heeres, H.J., 2011. Caprolactam from renewable resources: catalytic conversion of 5-hydroxymethylfurfural into caprolactone. *Angew. Chem.* 50(31), 7083-7087.
- [14] Chen, N., Wang, J., Zhao, Y., Deng, Y., 2018. Metabolic engineering of *Saccharomyces cerevisiae* for efficient production of glucaric acid at high titer. *Microb. Cell. Fact.* 17(1), 1-11.
- [15] Choe, B., Lee, S., Won, W., 2021. Coproduction of butene oligomers and adipic acid from lignocellulosic biomass: process design and evaluation. *Energy.* 235, 121278.
- [16] Coşgun, A., Günay, M.E., Yıldırım, R., 2023. A critical review of machine learning for lignocellulosic ethanol production via fermentation route. *Biofuel Res. J.* 10(2), 1859-1875.
- [17] Dake, S.B., Gholap, R.V., Chaudhari, R.V., 1987. Carbonylation of 1,4-butanediol diacetate using rhodium complex catalyst: a kinetic study. *Ind. Eng. Chem. Res.* 26(8), 1513-1518.
- [18] Davis, R.E., Grundl, N.J., Tao, L., Bidy, M.J., Tan, E.C., Beckham, G.T., Humbird, D., Thompson, D.N., Roni, M.S., 2018. Process design and economics for the conversion of lignocellulosic biomass to hydrocarbon fuels and coproducts: 2018 biochemical design case update. National Renewable Energy Laboratory, Colorado. NREL/TP-5100-71949.
- [19] Deng, Y., Mao, Y., 2015. Production of adipic acid by the native-occurring pathway in *Thermobifida fusca* B6. *J. Appl. Microbiol.* 119(4), 1057-1063.
- [20] Derrien, E., Mounquengui-Diallo, M., Perret, N., Marion, P., Pinel, C., Besson, M., 2017. Aerobic oxidation of glucose to glucaric acid under alkaline-free conditions: Au-Based bimetallic catalysts and the effect of residues in a hemicellulose hydrolysate. *Ind. Eng. Chem. Res.* 56(45), 13175-13189.
- [21] Dirkx, J.M.H., Van der Baan, H.S., 1981. The oxidation of gluconic acid with platinum on carbon as catalyst. *J. Catal.* 67(1), 14-20.
- [22] Dirkx, J.M., Van der Baan, H.S., Van den Broek, J.M.A.J.J., 1977. The preparation of D-glucaric acid by the oxidation of D-gluconic acid catalysed by platinum on carbon. *Carbohydr. Res.* 59(1), 63-72.
- [23] Dogbe, E.S., Mandegari, M., Görgens, J.F., 2020. Revitalizing the sugarcane industry by adding value to A-molasses in biorefineries. *Biofuel Bioprod. Biorefin.* 14(5), 1089-1104.
- [24] Dogbe, E.S., Mandegari, M.A., Görgens, J.F., 2018. Exergetic diagnosis and performance analysis of a typical sugar mill based on Aspen Plus® simulation of the process. *Energy.* 145, 614-625.
- [25] Dutta, S., Iris, K.M., Tsang, D.C., Ng, Y.H., Ok, Y.S., Sherwood, J., Clark, J.H., 2019. Green synthesis of gamma-valerolactone (GVL) through hydrogenation of biomass-derived levulinic acid using non-noble metal catalysts: a critical review. *Chem. Eng. J.* 372, 992-1006.
- [26] Ewing, T.A., Nouse, N., van Lint, M., van Haveren, J., Hugenholtz, J., van Es, D.S., 2022. Fermentation for the production of biobased chemicals in a circular economy: a perspective for the period 2022-2050. *Green Chem.* 24(17), 6373-6405.
- [27] Fallahi, A., Farzad, S., Mohtasebi, S.S., Mandegari, M., Görgens, J.F., Gupta, V.K., Lam, S.S., Tabatabaei, M., Aghbashlo, M., 2021. Sustainability assessment of sugarcane residues valorization to biobutadiene by exergy and exergoeconomic evaluation. *Renew. Sust. Energy Rev.* 147, 111214.
- [28] Farzad, S., Mandegari, M.A., Guo, M., Haigh, K.F., Shah, N., Görgens, J.F., 2017. Multi-product biorefineries from lignocelluloses: a pathway to revitalisation of the sugar industry?. *Biotechnol. Biofuels* 10, 1-24.
- [29] Fazzino, F., Pedullà, A., Calabrò, P.S., 2023. Boosting the circularity of waste management: pretreated mature landfill leachate enhances the anaerobic digestion of market waste. *Biofuel Res. J.* 10(1), 1764-1773.
- [30] Flederbach, B., Winch, J., 2019. Adipic acid production issue paper. ClimeCo Corporation, Boyertown, Pennsylvania.
- [31] Fruchey, O.S., Manzer, L.E., Dunuwila, D., Keen, B.T., Albin, B.A., Clinton, N.A., Dombek, B.D., 2011. Processes for producing adipic acid from fermentation broths containing diammonium adipate. U.S. Patent 20110269993A1.
- [32] Gheewala, S.H., 2023. Life cycle assessment for sustainability assessment of biofuels and bioproducts. *Biofuel Res. J.* 10(1), 1810-1815.
- [33] Grand View Research. 2021. Bio-based platform chemicals market." San Francisco, United States.
- [34] Gunukula, S., Anex, R.P., 2017. Techno-economic analysis of multiple bio-based routes to adipic acid. *Biofuel Bioprod. Biorefin.* 11(5), 897-907.
- [35] Guo, H., Liu, H., Jin, Y., Zhang, R., Yu, Y., Deng, L., Wang, F., 2022. Advances in research on the bio-production of 1,4-butanediol by the engineered microbes. *Biochem. Eng. J.* 185, 108478.
- [36] Han, J., 2016. A bio-based 'green' process for catalytic adipic acid production from lignocellulosic biomass using cellulose and hemicellulose derived γ -valerolactone. *Energy Convers. Manage.* 129, 75-80.
- [37] Humbird, D., Davis, R., Tao, L., Kinchin, C., Hsu, D., Aden, A., Schoen, P., Lukas, J., Olthof, B., Worley, M.J.B.B., Sexton, D., Dudgeon, D., 2011. Process design and economics for conversion of lignocellulosic biomass to ethanol. National Renewable Energy Laboratory, Colorado. NREL/TP-5100-51400
- [38] Jarunglumlert, T., Bampenrat, A., Sukkathanyawat, H., Pavasant, P., Prommuak, C., 2022. Enhancing the potential of sugarcane bagasse for the production of ENplus quality fuel pellets by torrefaction: an economic feasibility study. *Biofuel Res. J.* 9(4), 1707-1720.
- [39] Jin, X., Zhao, M., Vora, M., Shen, J., Zeng, C., Yan, W., Thapa, P.S., Subramanian, B., Chaudhari, R.V., 2016. Synergistic effects of bimetallic PtPd/TiO₂ nanocatalysts in oxidation of glucose to glucaric acid: structure dependent activity and selectivity. *Ind. Eng. Chem. Res.* 55(11), 2932-2945.
- [40] Kalle, G.P., Naik, S.C., 1986. Effect of controlled aeration on glycerol production in a sulphite process by *Saccharomyces Cerevisiae*. *Biotechnol. Bioeng.* 29(9), 1173-1175.
- [41] Kapanji, K.K., Haigh, K.F., Görgens, J.F., 2019. Techno-economic analysis of chemically catalysed lignocellulose biorefineries at a typical sugar mill: sorbitol or glucaric acid and electricity co-production. *Bioresour. Technol.* 289, 121635.
- [42] Kohlstedt, M., Starck, S., Barton, N., Stolzenberger, J., Selzer, M., Mehlmann, K., Schneider, R., Pleissner, D., Rinkel, J., Dickschat, J.S., Venus, J., B.J.H. van Duuren, J., Wittmann, C., 2018. From lignin to nylon: Cascaded chemical and biochemical conversion using metabolically engineered *Pseudomonas putida*. *Metab. Eng.* 47, 279-293.
- [43] Lee, J., Saha, B., Vlachos, D.G., 2016. Pt catalysts for efficient aerobic oxidation of glucose to glucaric acid in water. *Green Chem.* 18(13), 3815-3822.
- [44] Ling, C., Peabody, G.L., Salvachúa, D., Kim, Y.M., Kneucker, C.M., Calvey, C.H., Monninger, M.A., Munoz, N.M., Poirier, B.C., Ramirez, K.J., St. John, P.C., Woodworth, S.P., Magnuson, J.K., Burnum-Johnson, K.E., Guss, A.M., Johnson, C.W., Beckham, G.T., 2022. Muconic acid production from glucose and xylose in *Pseudomonas putida* via evolution and metabolic engineering. *Nat. Commun.* 13(1), 4925.
- [45] Louw, J., Farzad, S., Görgens, J.F., 2023. Polyethylene furanoate: technoeconomic analysis of biobased production. *Biofuel Bioprod. Biorefin.* 17(1), 135-152.
- [46] Moon, T.S., Dueber, J.E., Shiue, E., Prather, K.L.J., 2010. Use of modular, synthetic scaffolds for improved production of glucaric acid in engineered *E. coli*. *Metab. Eng.* 12(3), 298-305.
- [47] Moonsamy, T.A., Mandegari, M., Farzad, S., Görgens, J.F., 2022. A new insight into integrated first and second-generation bioethanol production from sugarcane. *Ind. Crops Prod.* 188, 115675.
- [48] Morakile, T., Mandegari, M., Farzad, S., Görgens, J.F. 2022. Comparative techno-economic assessment of sugarcane biorefineries producing glutamic acid, levulinic acid and xylitol from sugarcane. *Industrial Crops. Prod.* 184, 115053.
- [49] Motagamwala, A.H., Won, W., Sener, C., Alonso, D.M., Maravelias, C.T., Dumesic, J.A., 2018. Toward biomass-derived renewable plastics: production of 2,5-furandicarboxylic acid from fructose. *Sci. Adv.* 4, peaa9722.
- [50] Mounquengui-diallo, M., Vermersch, F., Perret, N., Pinel, C., Besson, M., 2018. Base free oxidation of 1,6-hexanediol to adipic acid over supported noble metal mono- and bimetallic catalysts. *Appl. Catal., A.* 551, 88-97.

- [51] Munene, C.N., Kampen, W.H., Njapau, H., 2002. Effects of altering fermentation parameters on glycerol and bioethanol production from cane molasses. *J. Sci. Food Agric.* 82(3), 309-314.
- [52] Nieder-Heitmann, M., Haigh, K., Görgens, J.F., 2019a. Process design and economic evaluation of integrated, multi-product biorefineries for the co-production of bio-energy, succinic acid, and polyhydroxybutyrate (PHB) from sugarcane bagasse and trash lignocelluloses. *Biofuel Bioprod. Biorefin.* 13(3), 599-617.
- [53] Nieder-Heitmann, M., Haigh, K., Louw, J., Görgens, J.F., 2019b. Economic evaluation and comparison of succinic acid and electricity co-production from sugarcane bagasse and trash lignocelluloses in a biorefinery, using different pretreatment methods: dilute acid (H₂SO₄), alkaline (NaOH), organosolv, ammonia fibre expansion (AFEX™), steam explosion (STEX), and wet oxidation. *Biofuel Bioprod. Biorefin.* 14(1), 55-77.
- [54] Niu, W., Draths, K.M., Frost, J.W., 2002. Benzene-free synthesis of adipic acid. *Biotechnol Prog.* 18(2), 201-211.
- [55] Nobbs, J.D., Zainal, N.Z.B., Tan, J., Drent, E., Stubbs, L.P., Li, C., Lim, S.C.Y., Kumbang, D.G.A., van Meurs, M., 2016. Bio-based pentaenoic acids as intermediates to higher value-added mono- and dicarboxylic acids. *Chemistry Select.* 1, 539-544.
- [56] Ntimbani, R.N., Farzad, S., Görgens, J.F., 2021. Techno-economics of one-stage and two-stage furfural production integrated with ethanol co-production from sugarcane lignocelluloses. *Biofuel Bioprod. Biorefin.* 15(6), 1900-1911.
- [57] OECD/FAO, 2019. OECD-FAO Agricultural outlook 2019-2028, OECD-FAO Agricultural Outlook. OECD Publishing, Paris.
- [58] Oh, M.Y., Jin, G., Lee, B., Kim, J., Won, W., 2022. Co-production of 1,4-pentanediol and adipic acid from corn stover with biomass-derived co-solvent: process synthesis and analysis. *J. Clean Prod.* 359, 131920.
- [59] Overkamp, K.M., Bakker, B.M., Kotter, P., Lutik, M.A.H., Dijken, J.P., Pronk, J.T., 2002. Metabolic engineering of glycerol production in *Saccharomyces cerevisiae*. *Appl. Environ. Microbiol.* 68, 2814-2821.
- [60] Paulik, F.E., Hershman, A., Knox, W.R., Roth, J.F., 1988. Carbonylation catalysts. US 4792620.
- [61] Pothakos, V., Debeer, N., Debonne, I., Rodriguez, A., Starr, J.N., Anderson, T., 2018. Fermentation titer optimization and impact on energy and water consumption during downstream processing. *Chem. Eng. Technol.* 41(12), 2358-2365.
- [62] Qi, L., Mui, Y.F., Lo, S.W., Lui, M.Y., Akien, G.R., Horváth, I.T., 2014. Catalytic conversion of fructose, glucose, and sucrose to 5-(hydroxymethyl)furfural and levulinic and formic acids in γ -valerolactone as a green solvent. *ACS Catal.* 4(5), 1470-1477.
- [63] Ratshoshi, B.K., Farzad, S., Görgens, J.F., 2021. Techno-economic assessment of polylactic acid and polybutylene succinate production in an integrated sugarcane biorefinery. *Biofuel Bioprod. Biorefin.* 15(6), 1871-1887.
- [64] Reizman, I.M.B., Stenger, A.R., Reisch, C.R., Gupta, A., Connors, N.C., Prather, K.L.J., 2015. Improvement of glucaric acid production in *E. coli* via dynamic control of metabolic fluxes. *Metab. Eng. Commun.* 2, 109-116.
- [65] Rios, J., Lebeau, J., Yang, T., Li, S., Lynch, M.D., 2021. A critical review on the progress and challenges to a more sustainable, cost competitive synthesis of adipic acid. *Green Chem.* 23(9), 3172-3190.
- [66] Satam, C.C., Realf, M.J., 2020. Comparison of two routes for the bio-based production of economically important C₄ streams. *J. Adv. Manuf. Process.* 2(3), p.e10054.
- [67] Silva-Moris, V.A., Rocha, S.C.S., 2006. Vibrofluidized bed drying of adipic acid. *Drying Tech.* 24(3), 303-313.
- [68] Skoczinski, P., Chinthapalli, R., Carus, M., Baltus, W., de Guzman, D., Kab, H., Raschka, A., Ravenstijn, J., 2020. Bio-based building blocks and polymers-global capacities, production and trends 2019-2024. nova-Institut GmbH, Germany.
- [69] Skoog, E., Shin, J.H., Saez-jimenez, V., Mapelli, V., Olsson, L., 2018. Biobased adipic acid-The challenge of developing the production host. *Biotechnol. Adv.* 36(8), 2248-2263.
- [70] Soltanian, S., Aghbashlo, M., Farzad, S., Tabatabaei, M., Mandegari, M., Görgens, J.F., 2019. Exergoeconomic analysis of lactic acid and power cogeneration from sugarcane residues through a biorefinery approach. *Renewable Energy.* 143, 872-889.
- [71] Steinwinder, T., Gill, E., Gerhardt, M., 2011. Process design of wastewater treatment for the NREL cellulosic ethanol model. National Renewable Energy Laboratory, Colorado. NREL/SR-5100-51838.
- [72] Thaore, V.B., Armstrong, R.D., Hutchings, G.J., Knight, D.W., Chadwick, D., Shah, N., 2020. Sustainable production of glucaric acid from corn stover via glucose oxidation: an assessment of homogeneous and heterogeneous catalytic oxidation production routes. *Chem. Eng. Res. Des.* 153, 337-349.
- [73] Vardon, D.R., Franden, M.A., Johnson, C.W., Karp, E.M., Guarnieri, M.T., Linger, J.G., Salm, M.J., Strathmann, T.J., Beckham, G.T., 2015. Adipic acid production from lignin. *Energy Environ. Sci.* 8(2), 617-628.
- [74] Vardon, D.R., Rorrer, N.A., Salvachúa, D., Settle, A.E., Johnson, C.W., Menart, M.J., Cleveland, N.S., Ciesielski, P.N., Steirer, K.X., Dorgan, J.R., Beckham, G.T., 2016. *Cis, cis*-Muconic acid: separation and catalysis to bio-adipic acid for nylon-6,6 polymerization. *Green Chem.* 18(11), 3397-3413.
- [75] Wei, L., Zhang, J., Deng, W., Xie, S., Zhang, Q., Wang, Y., 2019. Catalytic transformation of 2,5-furandicarboxylic acid to adipic acid over niobic acid-supported Pt nanoparticles. *Chem. Commun.* 55(55), 8013-8016.
- [76] Wong, P.K., Li, C., Stubbs, L., Van Meurs, M., Kumbang, D.G.A., Lim, S.C.Y., Drent, E., 2015. Synthesis of diacids. Patent US 20150183703A1.
- [77] Yan Cheah, W., Sankaran, R., Loke Show, P., Nilam Baizura Tg Ibrahim, T., Wayne Chew, K., Culaba, A., Chang, J.S., 2020. Pretreatment methods for lignocellulosic biofuels production: current advances, challenges and future prospects. *Biofuel Res. J.* 7(1), 1115-1127.
- [78] Yu, J.L., Xia, X.X., Zhong, J.J., Qian, Z.G., 2014. Direct biosynthesis of adipic acid from a synthetic pathway in recombinant *Escherichia coli*. *Biotechnol. Bioeng.* 111(12), 2580-2586.
- [79] Zhao, M., Huang, D., Zhang, X., Koffas, M.A.G., Zhou, J., Deng, Y., 2018. Metabolic engineering of *Escherichia coli* for producing adipic acid through the reverse adipate-degradation pathway. *Metab. Eng.* 47, 254-262.
- [80] Zhou, P., Zhang, Z., 2016. One-pot catalytic conversion of carbohydrates into furfural and 5-hydroxymethylfurfural. *Catal. Sci. Technol.* 6(11), 3694-3712.
- [81] Zhou, Y., Zhao, M., Zhou, S., Zhao, Y., Li, G., Deng, Y., 2020. Biosynthesis of adipic acid by a highly efficient induction-free system in *Escherichia coli*. *J. Biotechnol.* 314-315, 8-13.



Somayeh Farzad holds a PhD in Chemical Engineering (Petrochemical process design). Her research focus includes techno-economic assessment and environmental analysis of various technologies for biomass valorisation and environmentally friendly tire production. Her research profile on Google Scholar can be found at the following link:

<https://scholar.google.com/citations?user=yStEzJcAAAAJ&hl=en&authuser=2&oi=ao>



Yakim Cronje obtained her master's from Stellenbosch University. Her research focuses on designing bioprocess simulations for biorefineries.



Mohsen Mandegari has a Ph.D. in Chemical Engineering with a decade of in-depth research track in process simulation, techno-economic (TEA) and Life Cycle Assessment (LCA) of various biobased technologies along with experiences in the decarbonization of industries (transportation) and direct air capture (DAC) technologies. His research profile on Google Scholar can be found at the following link:

<https://scholar.google.com/citations?user=St19ansAAAAJ&hl=en&authuser=2&oi=ao>



Johann Görgens is a professor of Chemical Engineering at Stellenbosch University, where he leads a research group in sustainable process engineering, with a focus on development and assessment of biomass valorisation technologies. Prof Görgens holds PhD (Chemical Engineering) and MBA degrees, and has collaborated with various academic partners during research projects. His research profile on Google Scholar can be found at the following link:

<https://scholar.google.com/citations?user=6kYEuIcAAAAJ&hl=en&authuser=2>

Supplementary file

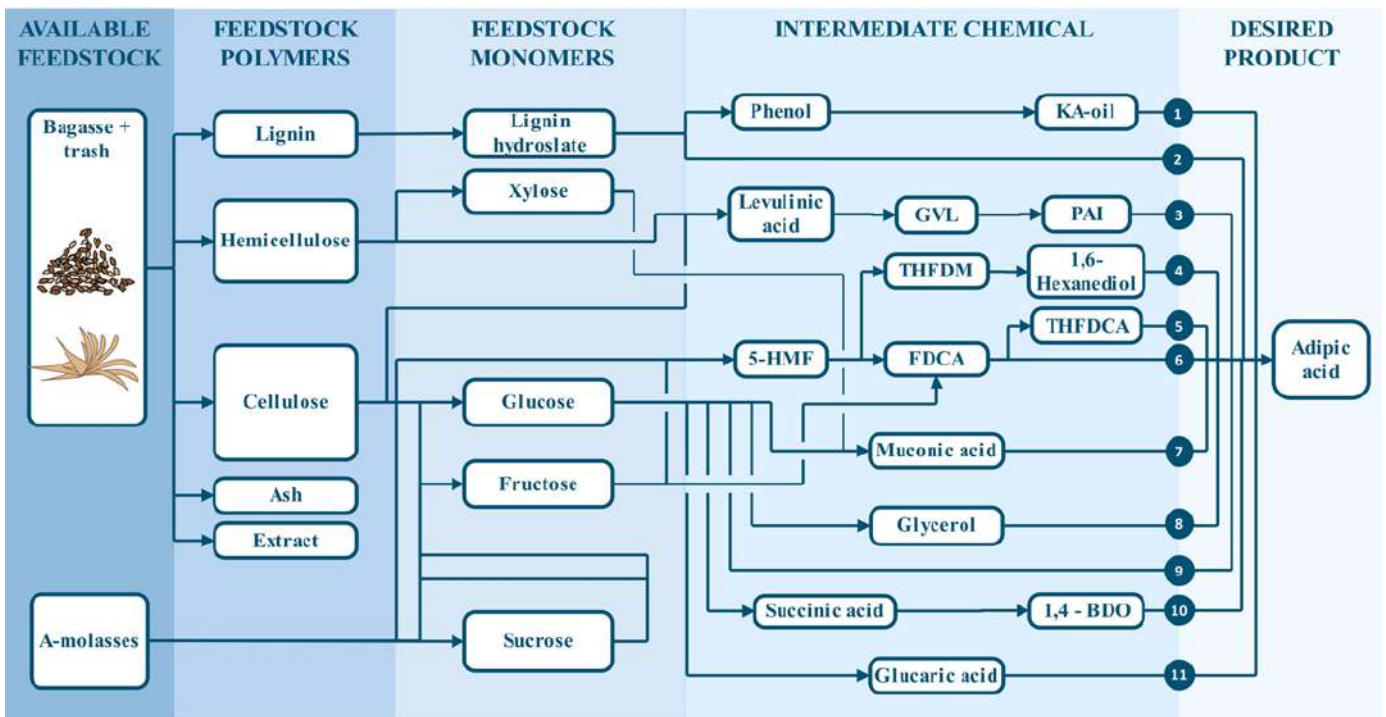

Fig. S1. Adipic acid production pathways identified in literature from available feedstocks (A-molasses and lignocellulosic feedstock, i.e., bagasse and brown leaves). KA-oil: Ketone alcohol oil; GVL: γ -valerolactone; PAI: Pentenoic acid isomers; THFDM: Tetrahydrofuran-dimethanol; 5-HMF: 5-hydroxymethylfurfural; FDCA: 2,5-Furandicarboxylic acid; THFDCA: Tetrahydrofuran-2,5-dicarboxylic acid; 1,4-BDO: 1,4-Butanediol.

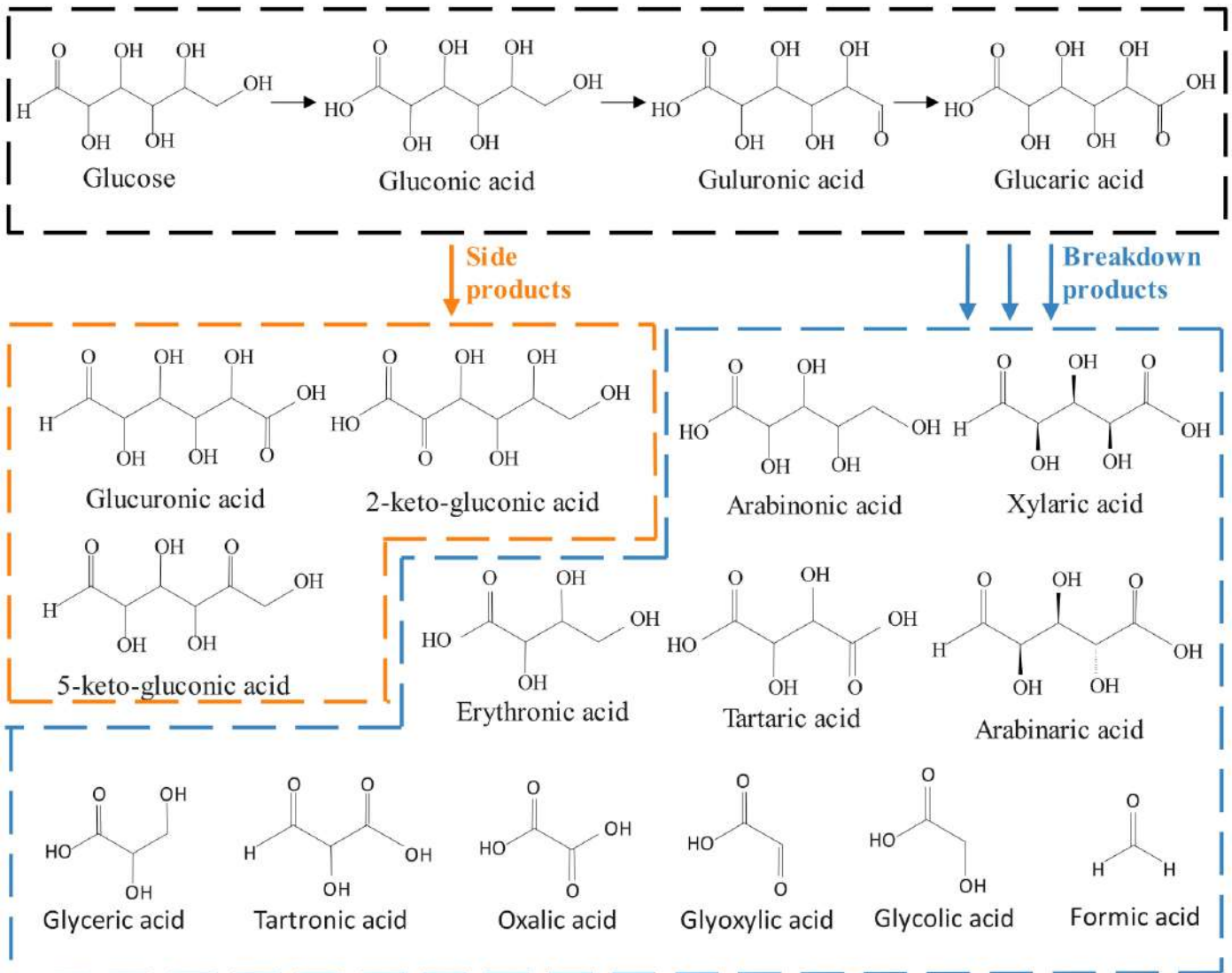

Fig. S2. Byproduct formation from glucaric acid production. Adapted from Dirx and van der Baan (1981); Lee et al. (2016); and Derrien et al. (2017).

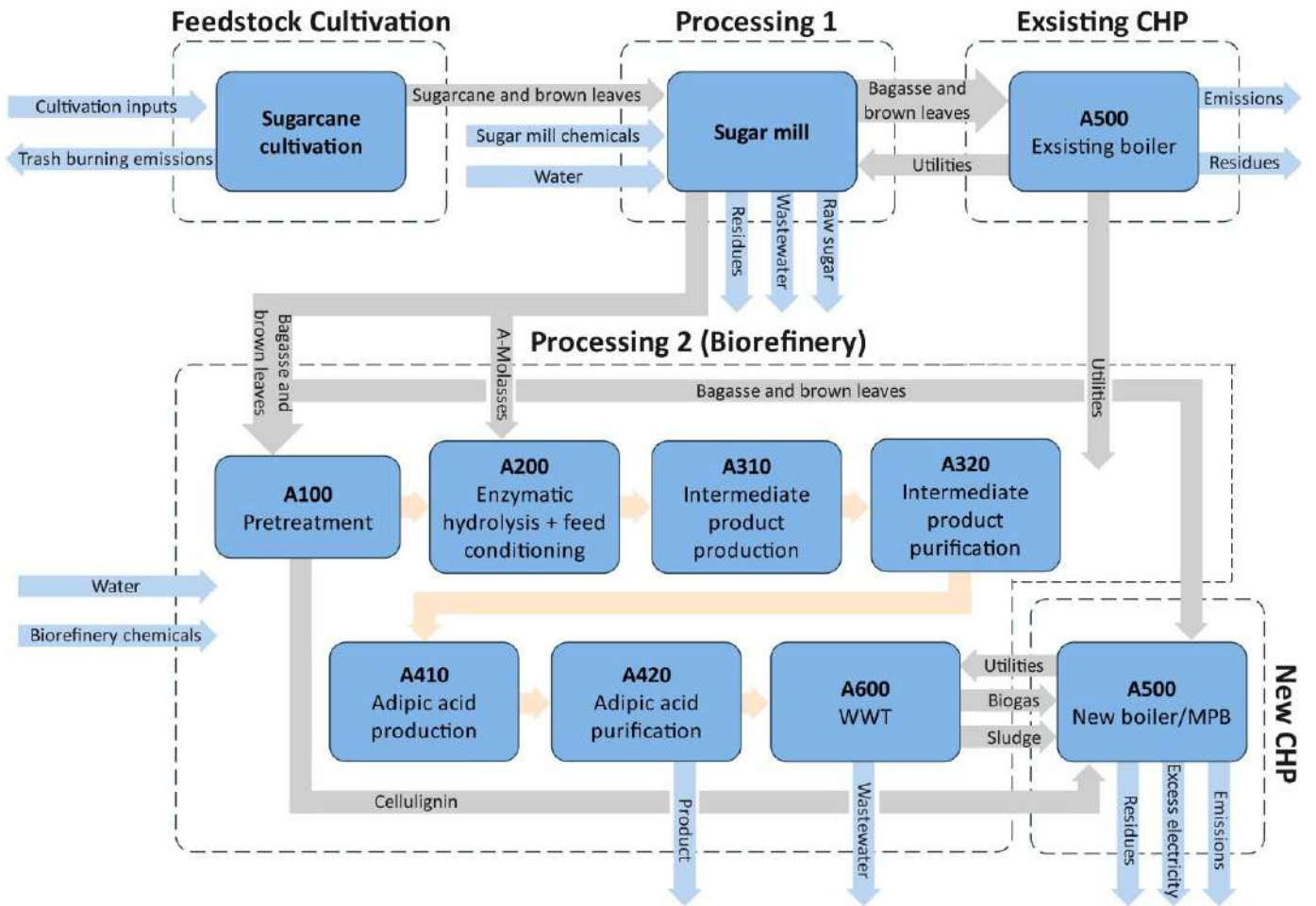

Fig. S3. The system boundaries of the GHG emission analysis.

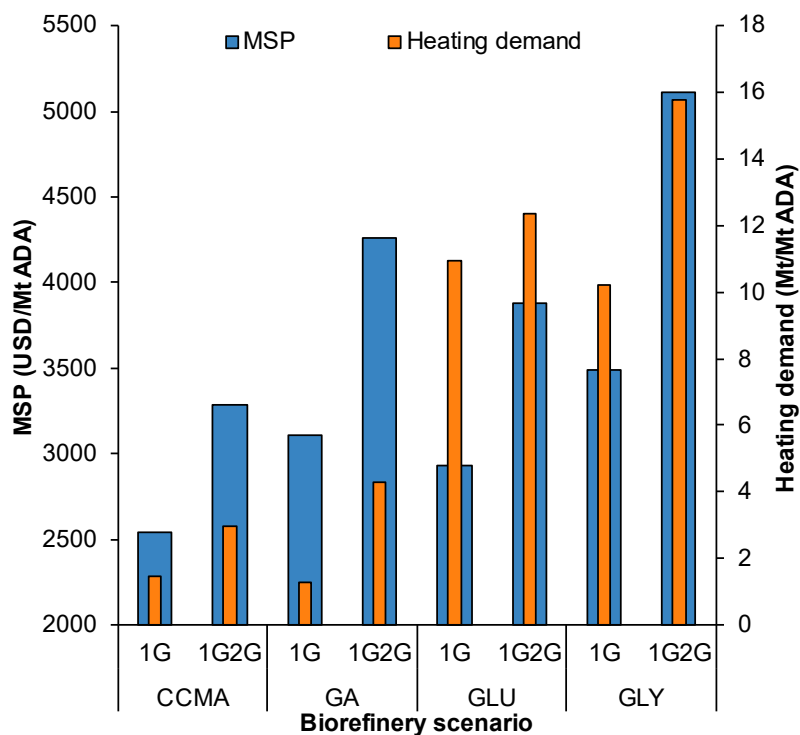

Fig. S4. Minimum selling price (MSP) of adipic acid (ADA) vs. heating demand.

Table S1.

GHG emission of the feedstock cultivation data used in RBS tool analysis.

Feedstock Information (Stalks)	Value	Reference
Feedstock yield	60,000 kg (wet)/ha	Singels et al. (2012)
Mass of seeds planted	9,884 kg/ha	(https://www.bighaat.com/)
Fertiliser	Value	Reference
Urea, as N	120 kg N/ha.yr	
Diammonium phosphate, as P ₂ O ₅	30 kg P ₂ O ₅ /ha.yr	Pradhan and Mbohwa, (2017)
Potassium chloride, as K ₂ O	75 kg K ₂ O/ha.yr	
Plant protection		
Pesticide type	Triazin	
Pesticide amount used	1.614 kg active component/ha.yr	Pradhan and Mbohwa (2017)
Herbicide type	Chloroantraniliprole	
Herbicide amount used	0.1326 kg active component/ha.yr	
Fuel and electricity	Value	Reference
Fuel type	Diesel	
Amount of fuel used	81.6 L/ha.yr	Pradhan and Mbohwa, (2017)
Electricity source	Grid	
Amount of electricity used	200.4 kWh/ha.yr	
Water	Value	Reference
Annual rainfall	621 mm/yr	(https://en.climate-data.org/)
Annual irrigation applied to feedstock crop	8,000 m ³ water/ha.yr	Pradhan and Mbohwa (2017)
Field burning	Value	Reference
Amount of residue burned*	7,845 kg residue (dry)/ha	Dogbe et al. (2019)

* Only considered in scenarios where trash (brown leaves) is not collected.

Table S2.
Heat map of utility demands per processing area.

		Pretreatment	Enzymatic hydrolysis and feed conditioning	Intermediate production	Intermediate purification	ADA production	ADA purification	CHP	WWT
<i>1G Scenarios</i>									
CCMA	CHILL*	0	0	0	30	0	13	0	0
	COOL	0	0	0	80	86	73	0	0
	STEAM	0	0.3	0.1	0	0.05	2	0	0.01
GA	CHILL	0	0	0	0	0	5	0	0
	COOL	0	0	164	1	237	49	0	0
	STEAM	0	0.02	0.2	0	3	2	0	0
GLU	CHILL	0	0	0	0	0	4	0	0
	COOL	0	0	0	0	34	766	0	39
	STEAM	0	0	0	0	1	17	0	1
GLY	CHILL	0	0	5	0	0.2	2	0	7
	COOL	0	10	0	0	0	99	0	695
	STEAM	0	0	0.1	0	0.004	18	0	0
<i>1G2G Scenarios</i>									
CCMA	CHILL	0	0	5	40	0	6	0	0
	COOL	0	0	68	85	86	74	0	20
	STEAM	2	0	0	0.1	0.1	2	1	0
GA	CHILL	0	0	0	0	0	4	0	0
	COOL	0	1	167	0	1	170	0	135
	STEAM	2	0	0.3	0	2	1	2	0.2
GLU	CHILL	0	0	0	0	0	4	0	0
	COOL	0	1	0	0	0	903	0	102
	STEAM	1	0	0	0	0	18	3	0
GLY	CHILL	0	0	6	0	0	1	0	0
	COOL	0	0	71	0	0	87	0	886
	STEAM	3	0	5	0	0	16	3	0.5

References

- [1] Derrien, E., Mounquengui-Diallo, M., Perret, N., Marion, P., Pinel, C., Besson, M., 2017. Aerobic oxidation of glucose to gluconic acid under alkaline-free conditions: Au-Based bimetallic catalysts and the effect of residues in a hemicellulose hydrolysate. *Ind. Eng. Chem. Res.* 56(45), 13175-13189.
- [2] Dirkx, J.M.H., van der Baan, H.S., 1981. The oxidation of gluconic acid with platinum on carbon as catalyst. *J. Catal.* 67(1), 14-20.
- [3] Dogbe, E.S., Mandegari, M., Görgens, J.F., 2019. Assessment of the thermodynamic performance improvement of a typical sugar mill through the integration of waste-heat recovery technologies. *Appl. Therm. Eng.* 158, 113768.
- [4] Lee, J., Saha, B., Vlachos, D.G., 2016. Pt catalysts for efficient aerobic oxidation of glucose to gluconic acid in water. *Green Chem.* 18(13), 3815-3822.
- [5] Pradhan, A., Mbohwa, C., 2017. Development of life cycle inventory (LCI) for sugarcane ethanol production in South Africa. *Int. Renewable Sust. Energy Conf. (IRSEC)* (pp. 1-4). IEEE.
- [6] Singels, A., Leslie, G., McFarlane, S., Sithole, P., Ferrer, S., Maher, G., 2012. Review of South African sugarcane production in the 2011/2012 season from an agricultural perspective. *Proc. S. Afr. Sug. Technol. Ass.* 30-46.